

YAESU
The radio

HF/50MHz TRANSCEIVER

FTDx101MP
FTDx101D

Operation Manual

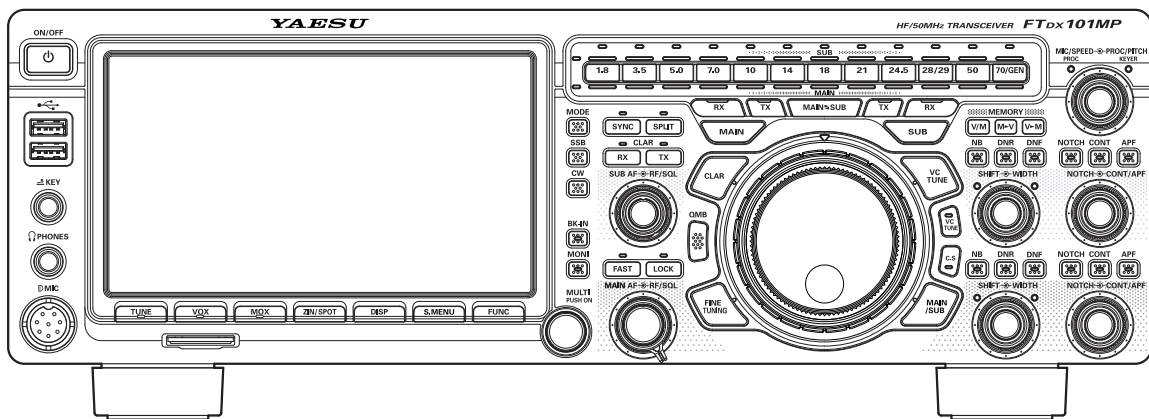

About this Manual

The FTDX101MP/FTDX101D is a leading-edge transceiver with a number of new and exciting features, some of which may be unfamiliar to you. In order to gain the most enjoyment and operating efficiency from the FTDX101MP/FTDX101D, we recommend that you read this manual in its entirety, and keep it handy for reference as you explore the many capabilities of this new transceiver.

Before using the FTDX101MP/FTDX101D, be sure to read this manual.

How to read this operation manual

Two methods are used to select an item displayed on the FTDX101 Function Screen: **“Operate by touching the item directly on the display”**; and **“Turn the [MULTI] knob to select the item and then press the [MULTI] knob”**.

Subsequently, in this manual, the operations that can be performed either by touching the Function Screen, or by turning and pressing the **[MULTI] knob** are abbreviated to **“Select [DISPLAY SETTING] → [DISPLAY] → [TFT DIMMER]”**; as described in the following:

Example: How to adjust the brightness of the display

1. Press the [FUNC] key to display the function screen.
2. Touch [DISPLAY SETTING] on the function screen, or rotate the [MULTI] knob to select [DISPLAY SETTING] and then press the [MULTI] knob.
3. Touch [DISPLAY] on the display or rotate the [MULTI] knob to select [DISPLAY] and then press the [MULTI] knob.
4. Touch the setting section of [TFT DIMMER] on the display, or rotate the [MULTI] knob to select [TFT DIMMER] and then press the [MULTI] knob.
5. Rotate the [MULTI] knob to adjust the brightness.

The following notations are also used in this manual:



This icon indicates cautions and alerts the user should be aware of.



This icon indicates helpful notes, tips and information.

The illustrations related to the screen display use the FTDX101D display. The displayed contents may differ in FTDX101MP.

Table of Contents

General Description.....	4	Front Panel Controls & Switches.....	32
Safety Precautions	6	Adjusts the VOX GAIN	33
Accessories & Options	8	Adjusts the VOX Delay Time	33
Supplied Accessories	8	Adjusts the VOX anti-trip sensitivity	33
Available options	8	QMB Channel Storage	35
Installation and Interconnections.....	9	QMB Channel Recall.....	35
Antenna Considerations	9	Confirm the contents of QMB	35
Antenna Connections	9	Changing the number of QMB channels	35
Power Cable Connections.....	10	Mark the operation band	35
FTDX101MP.....	10	Quick Split Operation	37
FTDX101D	11	Direct input of offset frequency.....	37
Microphone, Headphone, Key, Keyer and		Clarifier	39
FH-2 Connections	13	RX Clarifier	39
Linear Amplifier Interconnections	14	Adjust transmit frequency to the	
VL-1000 Linear Amplifier Interconnections..	14	offset frequency	39
Interfacing to Other Linear Amplifiers	15	TX Clarifier	39
Rear Panel.....	16	To offset the frequency with the	
SSM-75G Microphone Switches.....	18	TX Clarifier Adjust receive frequency	39
Be sure to study this information to		VC TUNE.....	40
maximize the receiver performance		Fine tune the tuning point.....	40
of the high-class FTDX101 series		C.S (Custom Select).....	40
shortwave transceiver.....	19	How to assign functions	40
Display Indications.....	20	MAIN/SUB	40
Meter Display	20	Switching the operation of the	
Filter Function Display.....	21	[RF/SQL] knob.....	42
Display only DSP filter		MAIN Band Operation	44
bandwidth information	21	Adjusting the Noise Attenuation	44
Frequency Display.....	21	Reduces longer duration pulse noise.....	44
Keyboard Frequency Entry.....	21	Set the MULTI knob to NB level	
Tuning in 1 MHz or 1 kHz Steps.....	21	adjustment knob	44
Important Receiver Settings	22	Adjust the GAIN of the CONTOUR Circuit ..	46
ANT (Switching the Antenna)	22	Sets the Bandwidth (“Q”) of the	
ATT (Attenuator).....	22	CONTOUR Circuit	46
IPO	22	Voice Communications (SSB and AM)	50
R.FIL (Roofing Filter Switching)	23	When transmitting in SSB or AM mode	50
AGC (Automatic Gain Control)	23	Speech Processor	51
Scope Display Setting	24	RF Power output control.....	51
CENTER.....	24	Parametric Microphone Equalizer	52
CURSOR.....	24	Setup the Parametric Microphone	
FIX.....	25	Equalizer	52
SPEED	27	Activate the Parametric Microphone	
PEAK.....	27	Equalizer	52
MARKER.....	27	Voice Memory.....	54
COLOR.....	27	Recording Your Own Voice in Memory.....	54
LEVEL	27	Checking the Recording	54
Other On-Screen Indications.....	29	Transmitting the Recorded Message	54
Screen Saver.....	30	Adjustable Receiver Audio Filter	55
Adjust contrast.....	30	Using the Automatic Antenna Tuner	56
Adjusting the brightness (Dimmer).....	30	ATU Operation.....	56
Font setting for frequency display	30		
Inputting the Call Sign	30		

CW Mode Operation.....	58	Memory Tune Operation.....	73
Adjusting the Sidetone Audio level.....	58	Moving Memory Data to the VFO register...	74
CW Delay Time Setting.....	58	Labeling Memories.....	74
CW Decode.....	59	Displaying the Memory Tag.....	74
CW Spotting (Zero-Beating).....	59	Scan Skip Setting.....	74
Setting of the Electronic Keyer.....	60	Memory Groups.....	75
Adjusting the Keyer Speed.....	60	Choosing the Desired Memory Group.....	75
Setting the Keyer Weight (Dot/Dash) Ratio.....	60	VFO and Memory Scanning.....	76
Reversing the Keyer Polarity.....	60	VFO/Memory Scan.....	76
Selecting the Keyer Operating Mode.....	60	Programmable Memory Scan (PMS).....	77
Contest Memory Keyer.....	61	Other Functions.....	78
Message Memory.....	61	Band Stack Operation.....	78
Storing a Message into Memory.....	61	TOT (Time Out Timer).....	78
Message Memory Programming		[MULTI] knob Step Increment Setting.....	78
(Using your Paddle).....	61	Operation on Alaska Emergency Frequency:	
Checking the CW Memory Contents.....	62	5167.5 kHz (U.S. Version Only).....	79
On-The-Air CW Message Playback.....	62	Screen capture.....	79
TEXT Memory.....	63	Using the SD Card.....	80
Text Memory Storage.....	63	SD Cards that can be used.....	80
Text Message Programming.....	63	Installing the SD card.....	80
Checking the CW Memory Contents.....	64	Removing the SD card.....	80
On-The-Air CW Message Playback.....	64	Formatting a SD card.....	80
FM Mode Operation.....	65	Saving Memory data and Setting	
Repeater Operation.....	65	Menu data.....	81
Tone Squelch Operation.....	65	Reading Memory and Set Menu data.....	82
RTTY (FSK) Operation.....	66	Display the SD Card Information.....	82
Connecting to a Personal Computer.....	66	Setting Menu.....	83
Connecting to the TU (Terminal Unit).....	66	Using the Menu.....	83
RTTY Decode.....	67	Resetting the Microprocessor.....	111
RTTY Text Memory.....	68	Optional Accessories.....	112
Text Message Programming on		FC-40 External Automatic Antenna Tuner	
TFT Screen.....	68	(for Wire Antenna).....	112
Text Message Programming on		Interconnections to FTDX101 series.....	112
FH-2 Remote Controller.....	68	Setup the FTDX101 series.....	113
Text Input.....	68	Optional FH-2 Control.....	114
On-The-Air RTTY Text Message Playback..	68	Specifications.....	115
DATA (PSK) Operation.....	69	General.....	115
Connecting to a Personal Computer.....	69	Transmitter.....	115
Connecting to the Data Communications		Receiver.....	116
Device.....	69	Index.....	117
PSK Decode.....	70	YAESU LIMITED WARRANTY.....	120
PSK Text Memory.....	71		
Text Message Programming on			
TFT Screen.....	71		
Text Message Programming on			
FH-2 Remote Controller.....	71		
Text Input.....	71		
On-The-Air PSK Text Message Playback....	71		
Memory Operation.....	72		
Memory Storage.....	72		
Erasing Memory Channel Data.....	72		
Check Memory Channel Status.....	73		
Recall a Memory Channel other than.....	73		
the last used VFO frequency.....	73		

General Description

Hybrid SDR configuration

In addition to the narrow band SDR receiver that boasts awesome basic performance, the FTDX101MP/FTDX101D has a hybrid SDR configuration utilizing an integrated direct sampling SDR receiver, which permits visualization of the spectrum of the entire band in real time.

By adopting the hybrid SDR method, and utilizing the features of the direct sampling method, wide-view displays of the information in the entire band in real time, and improved performance of the entire receiving circuit with the narrow band SDR technology down conversion method are possible.

Comes equipped with three* types of roofing filters

This transceiver is equipped with three types of roofing filters for 600 Hz, 3 kHz and 12 kHz bandwidths. These narrow band filters are especially useful on a very crowded band during contests, because they can dramatically attenuate powerful out-of-band signals in the first IF stage, and thus reduce their impact in the second stage. Further, the excellent dynamic range and IP3 characteristics optimize the processing of all signals ranging from faint to powerful.

* The 300 Hz roofing filter is also standard equipment on the MAIN band side of the FTDX101MP.

Adopts 3DSS/Hybrid Dual SDR Display

In addition to the conventional waterfall display, a 3DSS (3 Dimensions Spectrum Stream) image method has been newly adopted. The 3DSS image uses the horizontal axis (X axis) for frequency, the vertical axis (Y axis) for signal intensity, and the Z axis for time. Compared to the conventional waterfall method, the signal strength is displayed in three dimensions as well as in color, recognition of changes in the band conditions is instant, convenient and intuitive.

The 3DSS waterfall display has a choice of the mono display that displays only the MAIN frequency band; or the dual display that illustrates both the MAIN and SUB frequency bands.

The Hybrid Dual SDR Display presents two SDR outputs, narrow band SDR and direct sampling SDR, combined the same screen. Since the display color of each SDR output can be changed, the band received by the narrow band SDR receiver can be viewed while also observing the condition of the entire band.

High-brightness TFT full-color display with touch-panel functionality

The FTDX101MP/FTDX101D is equipped with a 7-inch full-color TFT display. Operating functions, including the receiving band noise and signal interference reduction tools, are graphically displayed. Even while involved in rigorous operations, such as DXpeditions and contests, the operator may instantly grasp the status of each function.

Filter Function Display monitors the status of the passband

In the upper part of the display, an S meter and a filter function display present the state of the pass-band. They are arranged independently for the MAIN Band and SUB Band respectively. In addition to the operating state of the interference removal functions, the filter function information is displayed. Not only can you grasp the operating status of WIDTH, SHIFT, NOTCH and CONTOUR at a glance, you can also view the status of the RF spectrum in the passband.

RF Pre-selector, Continuously Variable RF, & VC-TUNE

The newly developed VC tuning circuit drives a variable capacitor with a high-precision stepping motor and is comparable with a μ -Tuning mechanism, it achieves remarkable interference reduction characteristics with significant downscaling and maximum attenuation of -70 dB. When compared with the conventional preset method, which switches a coil and a capacitor with a relay, the high-precision stepping motor continuously follows the frequency inside the pass-band, there is no sense of discomfort as there is with relay switching. Even when there are multiple powerful signals in the band, fine adjustment to the optimal tuning point is possible.

Two selectable RF Stages amplify the desired signals from low band to high band

Push-pull RF amplifier AMP1, and AMP2 are low noise negative feedback RF amplifiers that may be selected or combined in series as is needed for various low-band, high-band, frequency and noise conditions. In addition, the IPO (Intercept Point Optimization) function maximizes the dynamic range and enhances the close multi-signal and inter-modulation characteristics of the receiver. The influence of strong broadcasting stations, especially in the low bands, can be minimized.

WIDTH and the continuously variable Bandwidth SHIFT features permit elimination of interfering signals

The WIDTH feature allows the bandwidth to be narrowed by rotating the WIDTH knob. The SHIFT feature, can eliminate interference in one side of the passband. Often, weak signals disappear due to interfering signals (including pile-ups). The interfering signals may be extracted, leaving only the desired signal, because of the unique DSP sharp filtering characteristics.

CONTOUR feature is renowned for effective noise reduction

Rather than using the DSP extremely sharp attenuation characteristics, the CONTOUR circuit provides gentle shaping of the DSP passband filter, and can thus attenuate or peak bandwidth components in segments. The interfering signal can be naturally shaped without having part of the signal suddenly disrupted. The contour function is very effective in making the desired signal rise out of the interference.

DNR (Digital Noise Reduction) by DSP digital processing

The incorporated digital noise reduction circuit may be set to the optimal working algorithm by varying the 15 step parameters according to the noise type.

NOTCH feature can eliminate an unwanted heterodyne, and the DNF feature can instantly attenuate multiple heterodyne signals

When interfering beat signals are present in the receiver passband, the IF NOTCH feature can significantly eliminate a narrow portion of the passband and remove the interfering signal. Moreover, when there are multiple interfering signals, the DSP DNF (Digital Notch Filter) Automatic Tracking System can be effective, even when an interfering frequency is changing.

ABI (Active Band Indicator)

Band keys are arranged in a row at the top above the main dial so that the operation status of the MAIN and SUB Bands can be checked at a glance. The band selected on the MAIN side is white, the band selected on the SUB side is blue. The white and blue correspond to the colors of the MAIN and SUB Band Switches.

When transmitting, the LED on the transmission band turns red. It is possible to instantly distinguish which band is transmitting and thus prevent erroneous operation.

Additionally, when the band key is pressed and held, the LED lights up in orange, so you can use this to display a band connected with an antenna, display a band to be operated with a DXpedition, etc., or as a MEMO.

MPVD (MULTI PURPOSE VFO OUTER DIAL)

A large multi-functional ring, cut from high-grade aluminum is placed on the outside of the Main Dial. It is frequently used for the SUB VFO dial, VC tune, Clarifier or a CS (Custom select) function. The operator may assign favorite functions to the MPVD that can then be operated with one touch. The ring can be used to adjust important functions without releasing your hand from the Main Dial. This feature can be a great convenience in the ever-changing shortwave radio communications.

Reliable High-output Final Amplifier Stage

FTDX101MP (200W) power amplifier utilizes push-pull VRF150 MOS FET devices, operating at 50V, with excellent linearity, low distortion and high voltage tolerance. By optimizing the bias circuit for the optimal operating points, a high-quality and stable output with low distortion is realized.

FTDX101D (100W) power amplifier utilizes a pair of RD100HHF1 transistors in a push-pull RF arrangement that delivers 100 watts of low-distortion, high-quality transmitter power.

Safety Precautions

Note beforehand that the company shall not be liable for any damages suffered by the customer or third parties in using this product, or for any failures and faults that occur during the use or misuse of this product, unless otherwise provided for under the law.

Type and meaning of the marks



DANGER

This mark indicates an imminently hazardous situation, which, if not avoided, could result in death or serious injury.



WARNING

This mark indicates a potentially hazardous situation, which, if not avoided, could result in death or serious injury.



CAUTION

This mark indicates a potentially hazardous situation, which, if not avoided, may result in minor or moderate injury or only property damage.

Type and meaning of symbols



Prohibited actions that must not be attempted, in order to use this radio safely. For example,  signifies that disassembly is prohibited.



Precautions that must be adhered to in order to use this radio safely. For example,  signifies that the power supply is to be disconnected.



DANGER



Do not use the device in “regions or aircrafts and vehicles where its use is prohibited” such as in hospitals and airplanes.

This may exert an impact on electronic and medical devices.



Do not use this product while driving or riding a motorbike. This may result in accidents.

Make sure to stop the car in a safe location first before use if the device is going to be used by the driver.



Do not transmit in crowded places in consideration of people who are fitted with medical devices such as heart pacemakers.

Electromagnetic waves from the device may affect the medical device, resulting in accidents caused by malfunctions.



Never touch the antenna during transmission.

This may result in injury, electric shock and equipment failure.



Do not operate the device when flammable gas is generated.

Doing so may result in fire and explosion.



When an alarm goes off with the external antenna connected, cut off the power supply to this radio immediately and disconnect the external antenna from this radio.

If not, this may result in fire, electric shock and equipment failure due to thunder.



Do not touch any liquid leaking from the liquid display with your bare hands.

There is a risk of chemical burns occurring when the liquid comes into contact with the skin or gets into the eyes. In this case, seek medical treatment immediately.



WARNING



Do not use voltages other than the specified power supply voltage.

Doing so may result in fire and electric shock.



Do not transmit continuously for long periods of time.

This may cause the temperature of the main body to rise and result in burns and failures due to overheating.



Do not dismantle or modify the device.

This may result in injury, electric shock and equipment failure.



Do not handle the power plug and connector etc. with wet hands. Also do not plug and unplug the power plug with wet hands.

This may result in injury, liquid leak, electric shock and equipment failure.



Do not use fuses other than those specified.

Doing so may result in fire and equipment failure.



When smoke or strange odors are emitted from the radio, turn off the power and disconnect the power cord from the socket.

This may result in fire, liquid leak, overheating, damage, ignition and equipment failure. Please contact our company customer support or the retail store where you purchased the device.



Keep the power plug pins and the surrounding areas clean at all times.

This may result in fire, liquid leak, overheating, breakage, ignition etc.



Disconnect the power cord and connection cables before incorporating items sold separately and replacing the fuse.

This may result in fire, electric shock and equipment failure.



Never cut off the fuse holder of the DC power cord.

This may cause short-circuiting and result in ignition and fire.

- Do not allow metallic objects such as wires and water to get inside the product.**
This may result in fire, electric shock and equipment failure.
- Do not place the device in areas that may get wet easily (e.g. near a humidifier).**
This may result in fire, electric shock and equipment failure.
- When connecting a DC power cord, pay due care not to mix up the positive and negative polarities.**
This may result in fire, electric shock and equipment failure.
- Do not use DC power cords other than the one enclosed or specified.**
This may result in fire, electric shock and equipment failure.
- Do not bend, twist, pull, heat and modify the power cord and connection cables in an unreasonable manner.**
This may cut or damage the cables and result in fire, electric shock and equipment failure.
- Do not pull the cable when plugging and unplugging the power cord and connection cables.**
Please hold the plug or connector when unplugging. If not, this may result in fire, electric shock and equipment failure.

- Refrain from using headphones and earphones at a loud volume.**
Continuous exposure to loud volumes may result in hearing impairment.
- Do not use the device when the power cord and connection cables are damaged, and when the DC power connector cannot be plugged in tightly.**
Please contact our company customer support or the retail store where you purchased the device as this may result in fire, electric shock and equipment failure.
- Follow the instructions given when installing items sold separately and replacing the fuse.**
This may result in fire, electric shock and equipment failure.
- Do not use the device when the alarm goes off.**
For safety reasons, please pull the power plug of the DC power equipment connected to the product out of the AC socket.
Never touch the antenna as well. This may result in fire, electric shock and equipment failure due to thunder.

CAUTION

- Do not place this device near a heating instrument or in a location exposed to direct sunlight.**
This may result in deformation and discoloration.
- Do not place this device in a location where there is a lot of dust and humidity.**
Doing so may result in fire and equipment failure.
- Stay as far away from the antenna as possible during transmission.**
Long-term exposure to electromagnetic radiation may have a negative effect on the human body.
- Do not wipe the case using thinner and benzene etc.**
Please use a soft and dry piece of cloth to wipe away the stains on the case.
- Keep out of the reach of small children.**
If not, this may result in injuries to children.
- Do not put heavy objects on top of the power cord and connection cables.**
This may damage the power cord and connection cables, resulting in fire and electric shock.
- Do not transmit near the television and radio.**
This may result in electromagnetic interference.
- Do not use optional products other than those specified by our company.**
If not, this may result in equipment failure.
- When using the device in a hybrid car or fuel-saving car, make sure to check with the car manufacturer before using.**
The device may not be able to receive transmissions normally due to the influence of noises from the electrical devices (inverters etc.) fitted in the car.

- Do not turn on the volume too high when using a headphone or earphone.**
This may result in hearing impairment.
- For safety reasons, switch off the power and pull out the DC power cord connected to the DC power connector when the device is not going to be used for a long period of time.**
If not, this may result in fire and overheating.
- Do not throw or subject the device to strong impact forces.**
This may result in equipment failure.
- Do not put this device near magnetic cards and video tapes.**
The data in the cash card and video tape etc. may be erased.
- Do not place the device on an unsteady or sloping surface, or in a location where there is a lot of vibration.**
The device may fall over or drop, resulting in fire, injury and equipment failure.
- Do not stand on top of the product, and do not place heavy objects on top or insert objects inside it.**
If not, this may result in equipment failure.
- Do not use a microphone other than those specified when connecting a microphone to the device.**
If not, this may result in equipment failure.

Accessories & Options

Supplied Accessories



Hand Microphone SSM-75G

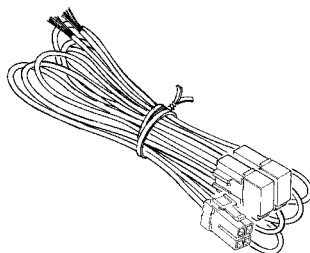

DC Power Cord
(FTDX101D only)

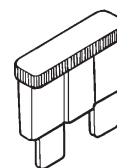

Spare Fuse (25A)
(FTDX101D only)

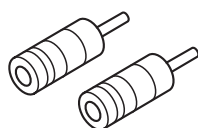

RCA Plug

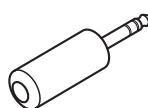

3.5 mm 3-contact Plug

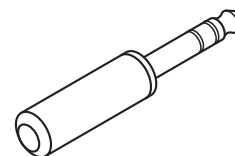

6.3 mm 3-contact Plug

- Operation Manual
- World Map
- Circuit Diagrams
- Sticker
- The following items are included only with FTDX101MP:
 - External Power Supply with Speaker FPS-101
 - AC Power Cord (for FPS-101)
 - DC Power Cord (for FPS-101) (USA version: T9101692, Asian and European version: T9207902)
 - Speaker Cord (connect FTDX101MP and FPS-101)
 - 2 Cable brackets (USA version only)
 - 2 Cable clamps (USA version only)
 - 2 Screws (3 x 8) (USA version only)

Available options

- | | |
|---|-----------------|
| • Hand Microphone (equivalent to the supplied microphone) | SSM-75G |
| • Reference Microphone | M-1 |
| • Dual Element Microphone | M-100 |
| • Ultra-High-Fidelity Desktop Microphone | MD-200A8X |
| • Desktop Microphone | MD-100A8X |
| • Lightweight Stereo Headphone | YH-77STA |
| • External Speaker | SP-101 |
| • External Automatic Antenna Tuner | FC-40 |
| • Remote Control Keypad | FH-2 |
| • Linear Amplifier/AC Power Supply | VL-1000/VP-1000 |
| • VL-1000 Linear Amplifier Connection Cable | CT-178 |

Please contact YAESU for the following options.

- | | |
|---|-----------|
| • VC-Tuning Unit (for SUB Band) | VCT-101* |
| • CW Narrow Filter (C/F: 9.005MHz, B/W: 300Hz, for MAIN Band) | XF-128CN* |
| • CW Narrow Filter (C/F: 8.900MHz, B/W: 300Hz, for SUB Band) | XF-129CN |
| • SSB Narrow Filter (9.005MHz, B/W: 1.2kHz, for MAIN Band) | XF-128SN |
| • SSB Narrow Filter (8.900MHz, B/W: 1.2kHz, for SUB Band) | XF-129SN |

* Included with FTDX101MP.

Installation and Interconnections

Antenna Considerations

The FTDX101MP/FTDX101D is designed to connect to a 50 Ohm resistive impedance antenna at the Amateur operating frequencies. Select an appropriate antenna (dipole antenna, YAGI antenna, cubical quad antenna, etc.) that is suitable for the chosen operation and bands.

Construct the antenna and coaxial cable, or use a suitable antenna tuner, to maintain the impedance presented to the FTDX101MP/FTDX101D antenna connector for an SWR of 1.5 or less. Careful preparation of the antenna and/or tuner will permit maximum performance, and protect the transceiver from damage.

High transmitter RF voltages may be present on the antenna; install it so it will not be easily touched when in operation.

Antenna Connections

Carefully follow the illustration regarding the proper connection of antennas and coaxial cables.

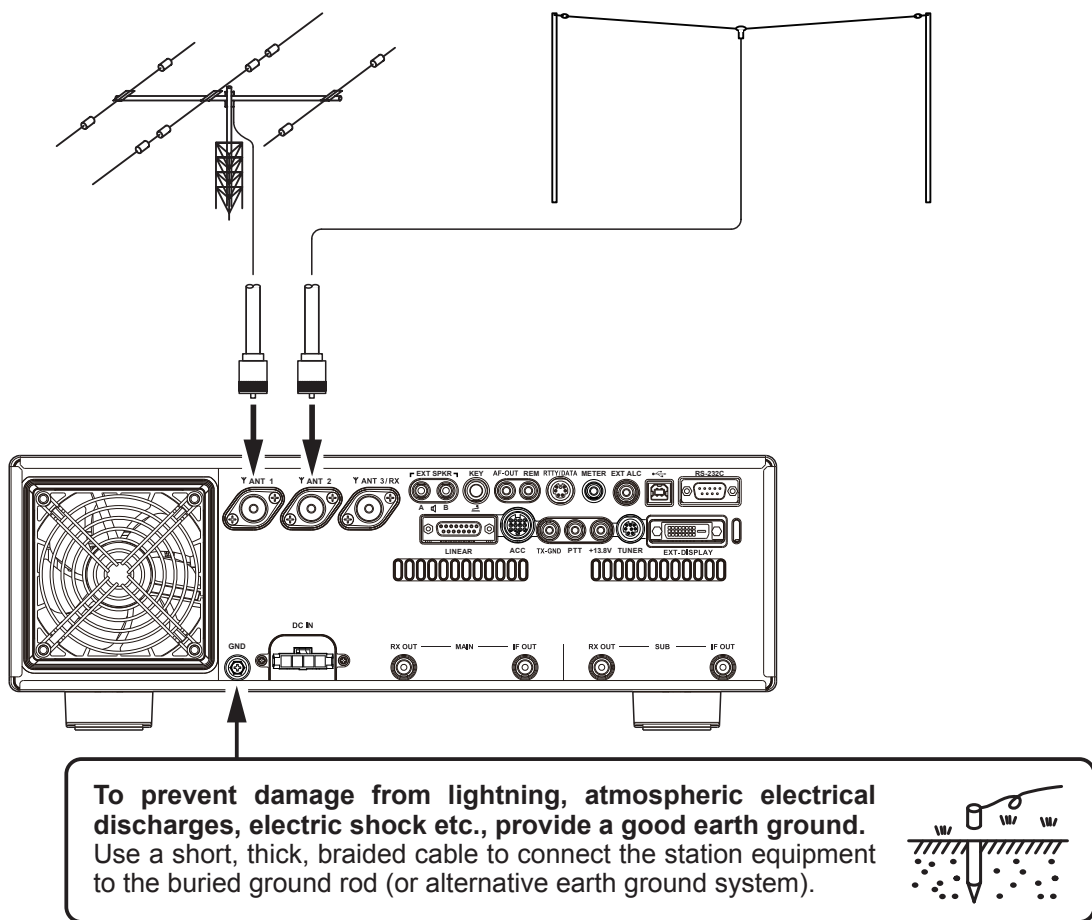

Power Cable Connections

• FTDX101MP

Refer to the illustration for the proper connection of the FPS-101 Power Supply.

Use the DC power cable supplied with the FTDX101MP to make the power connection to the FPS-101 power supply.



- Connect the FTDX101MP and FPS-101 with the supplied speaker cable so audio can be output from the FPS-101's built-in speaker.
- When connected to EXT SPKR terminal "A", audio of "MAIN band and SUB band" will be output from the built-in speaker of FPS-101.
- When connected to EXT SPKR terminal "B", audio of "MAIN band" is output from the built-in speaker of FPS-101, and audio of "SUB band" is output from the speaker of the FTDX101MP.

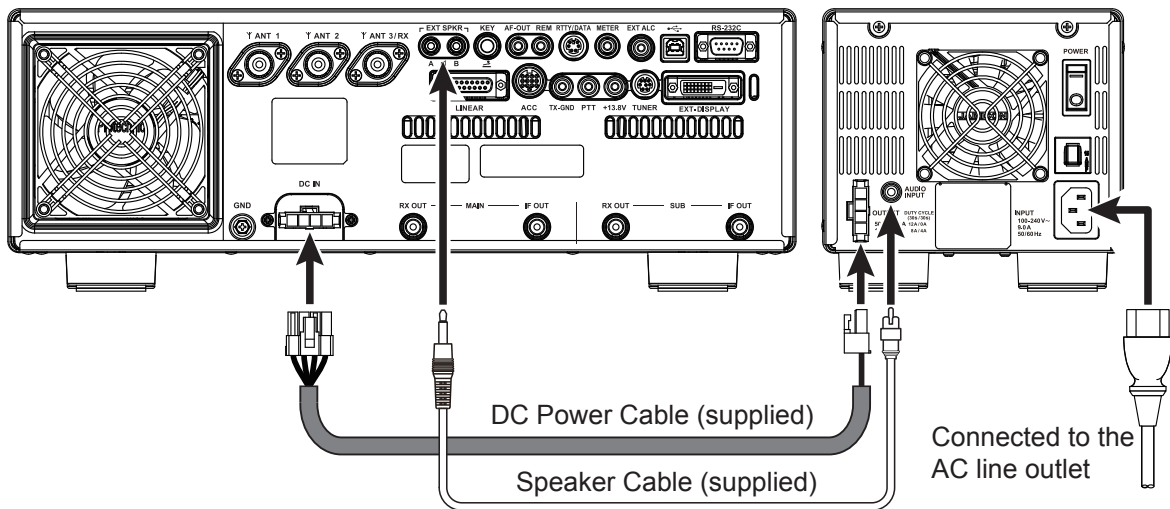

Connecting the DC power cable (USA version only)

Connect the DC Power Cable using the supplied Cable brackets (with Cable clamps), referring to the figures below.

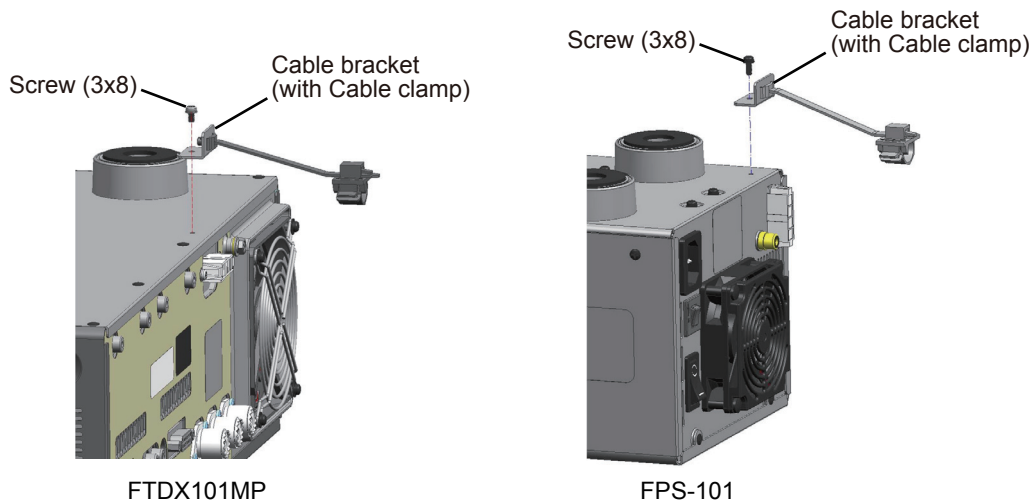

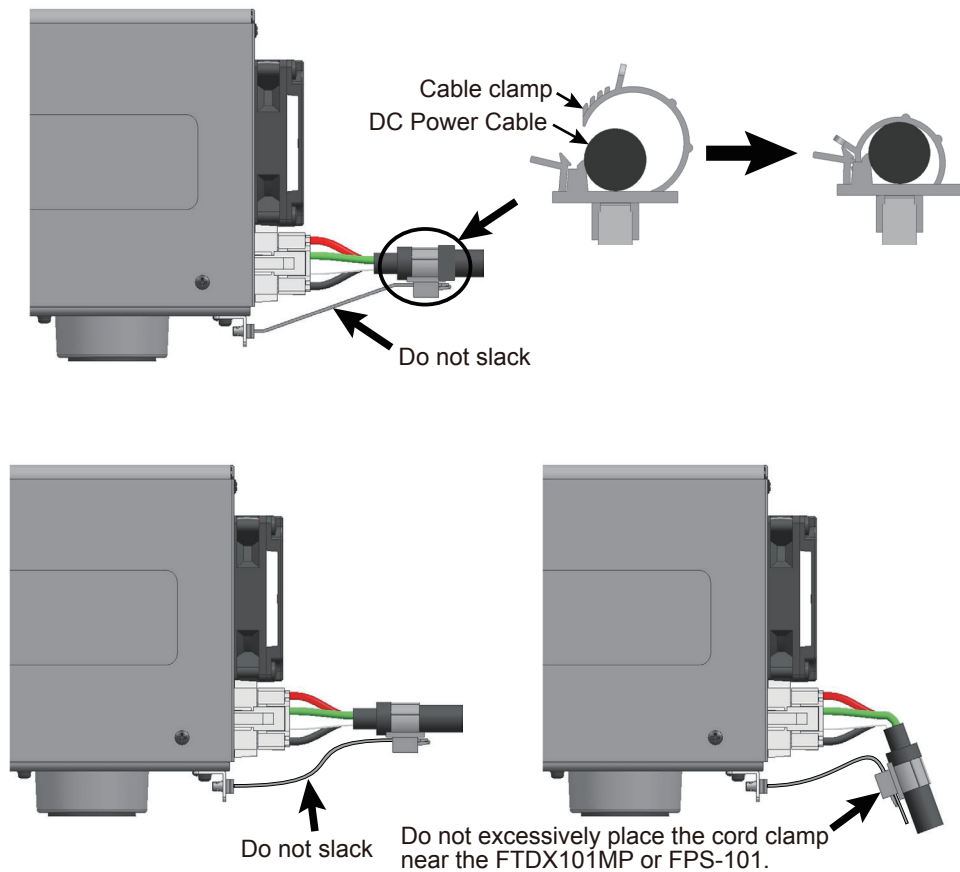

• **FTDX101D**

Carefully follow the illustrations regarding the proper connection of the DC power cable. Use the DC power cable supplied with the FTDX101D to make the power connections to the power supply.

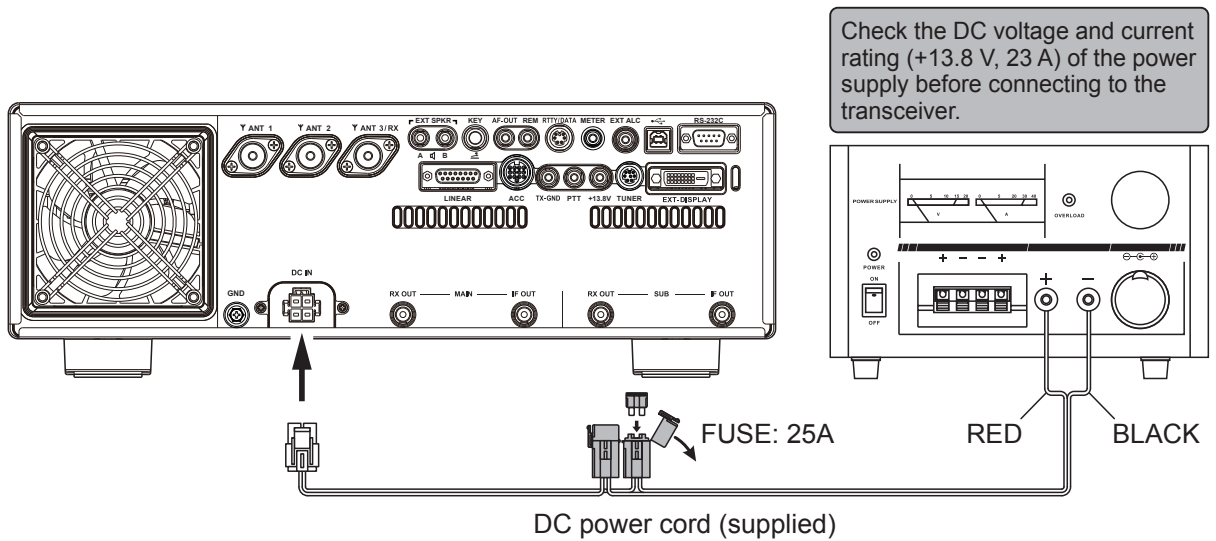

Installation guidelines

- Do not expose the transceiver to direct sunshine.
- Do not expose the transceiver to dust or high humidity.
- Ensure adequate ventilation around the transceiver, to prevent heat build-up and possible reduction of performance due over heating.
- Do not install the transceiver in a mechanically unstable location, or where objects may fall onto it from above.
- When installing the FTDX101MP and FPS-101, be careful not to forcibly bend or pull the power cable.
- Do not place heavy objects on top of the power cable.
- Do not use a power cable other than the one that is provided.
- To minimize the possibility of interference to home entertainment devices, take all precautionary steps including separation of TV/FM antennas from Amateur transmitting antennas to the greatest extent possible. Keep the transmitting coaxial cables separated from cables connected to home entertainment devices.
- Make sure to turn the transceiver OFF and disconnect all cables before moving the FTDX101MP or FPS-101.
- The AC Power Cord connected to a socket-outlet with earthing connection. A socket-outlet with earthing connection shall connect to protective earthing conductor.

Caution

Be sure that both the transceiver Front Panel POWER switch and the FPS-101 Main Power switch are both turned OFF any time you plug or unplug the power cable to the FTDX101MP and FPS-101. This will avoid potentially damaging electrical spikes and electrical shock.

When disconnecting the power cable, hold the connector, press the lock tab to release it and pull the plug from the connector. Pulling the power cable without releasing the lock may cause a failure.

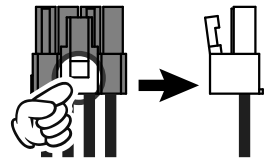

Microphone, Headphone, Key, Keyer and FH-2 Connections

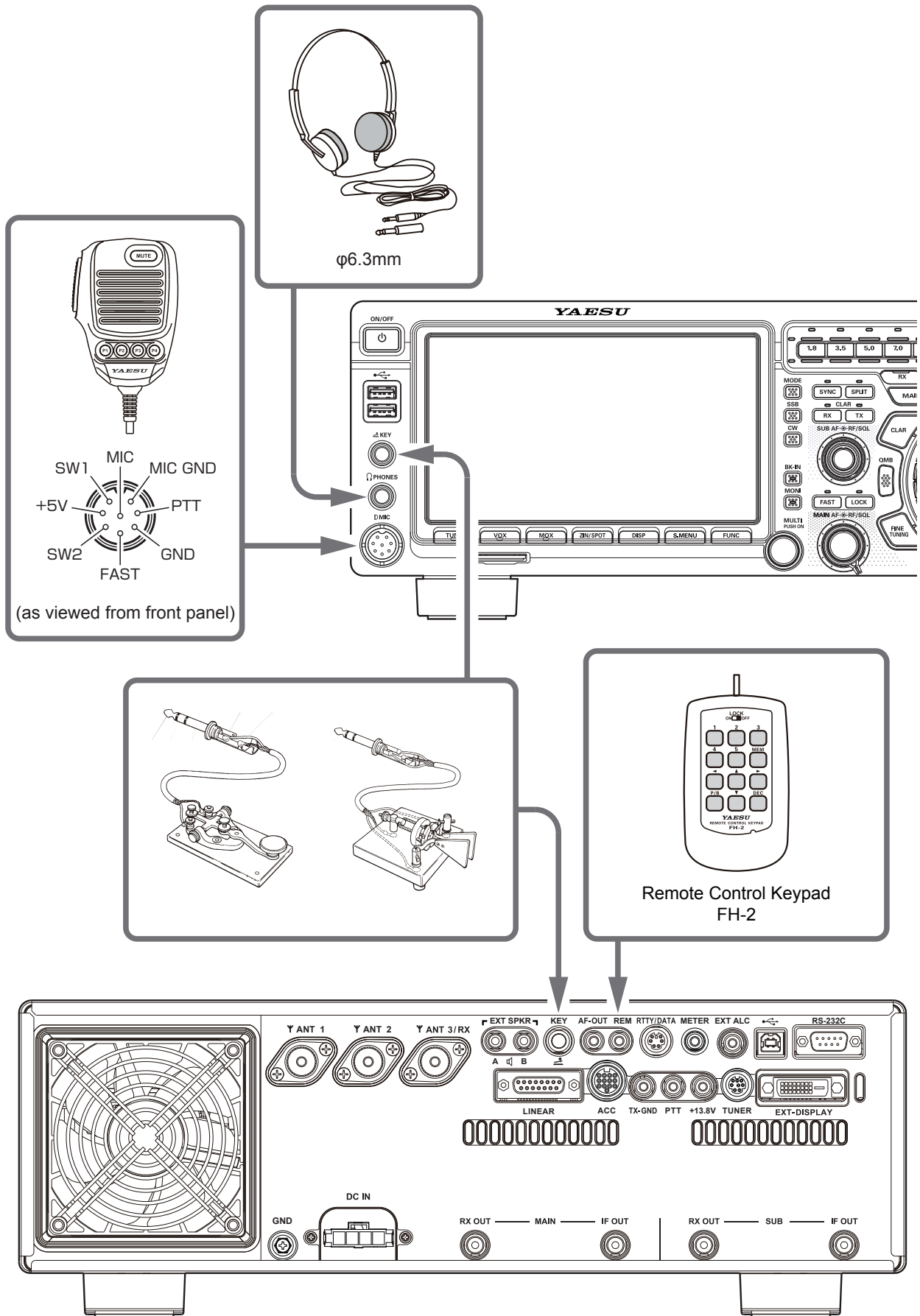

Key-up voltage on the front key jack is approximately +3.3 V DC, and key-down current is approximately 1 mA. Key-up voltage on the rear key jack is approximately +5.0 V DC, and key-down current is approximately 3 mA.

Linear Amplifier Interconnections



Be sure that both the FTDX101 series and VL-1000 are turned OFF, and then follow the installation recommendations contained in the below illustration.

• VL-1000 Linear Amplifier Interconnections



Since the **FTDX101MP** has a high transmission output of 200 W, be sure to turn ON the ATT switch of the VL-1000. Using the amplifier with the ATT switch "OFF" may damage the VL-1000.



- Refer to the VL-1000 Operating Manual for details regarding amplifier operation.
- Do not attempt to connect or disconnect coaxial cables when your hands are wet.

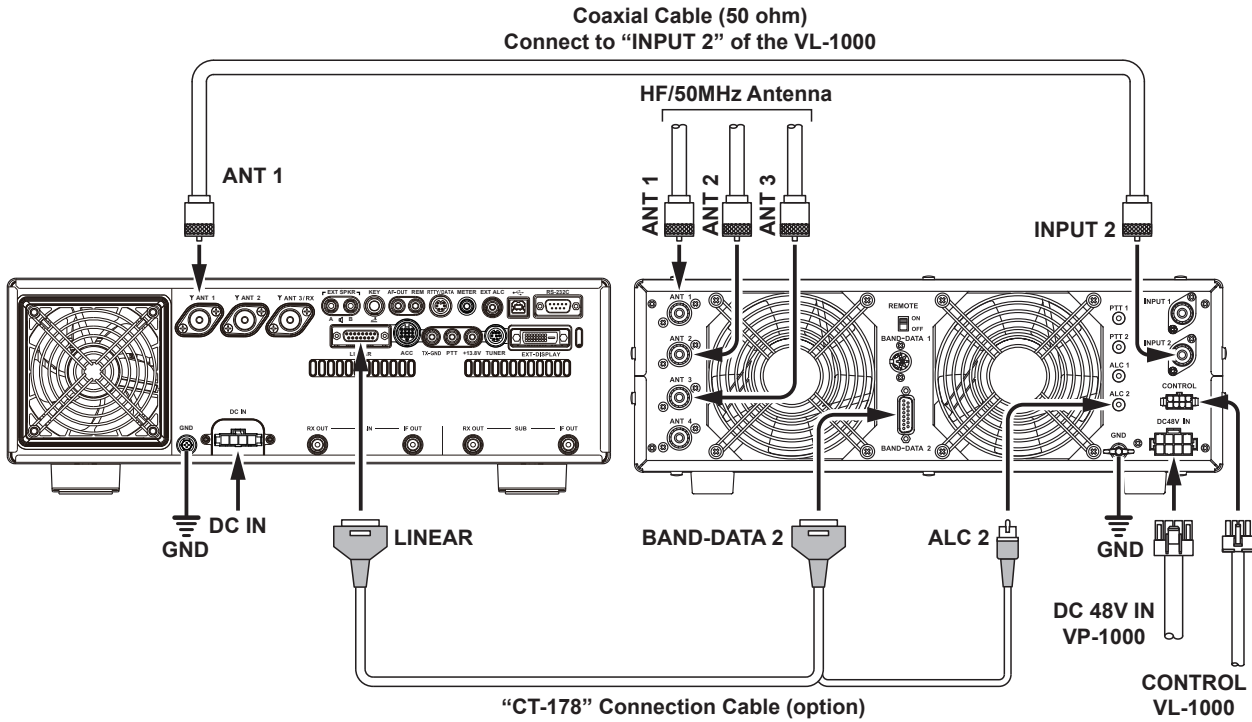

The figure above shows the FTDX101MP rear panel connections with the VL-1000.

• Interfacing to Other Linear Amplifiers



- The TX GND OUT pin (pin 2) of the LINEAR jack is a transistor “open collector” circuit. It is capable of handling positive relay coil voltages up to +60VDC at 200 mA or +30 VDC at 1 A.
- When using multiple linear amplifiers for different bands, you must provide external band switching of the “Linear Tx” relay control line from the “TX GND OUT” line at the LINEAR jack.



Do not exceed the maximum voltage or current ratings for the “TX GND OUT” pin (pin 2) of the LINEAR jack. This line is not compatible with negative DC voltages, or AC voltages of any magnitude.

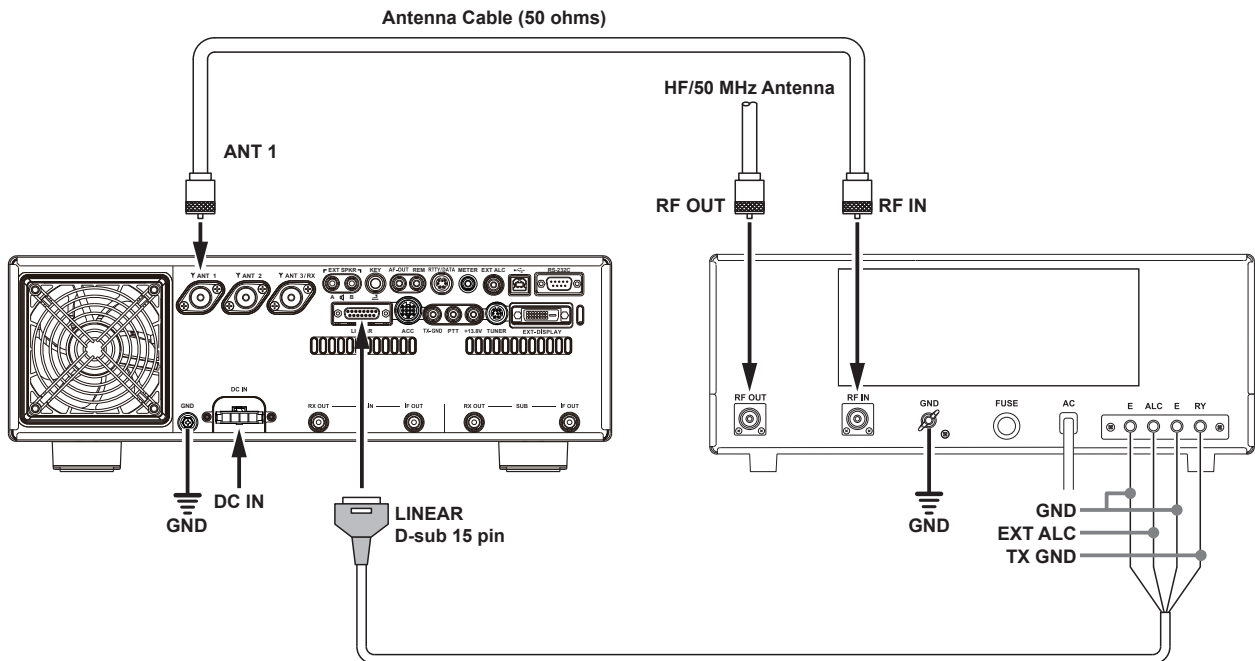

The figure above shows the FTDX101MP rear panel connections to other linear amplifiers.

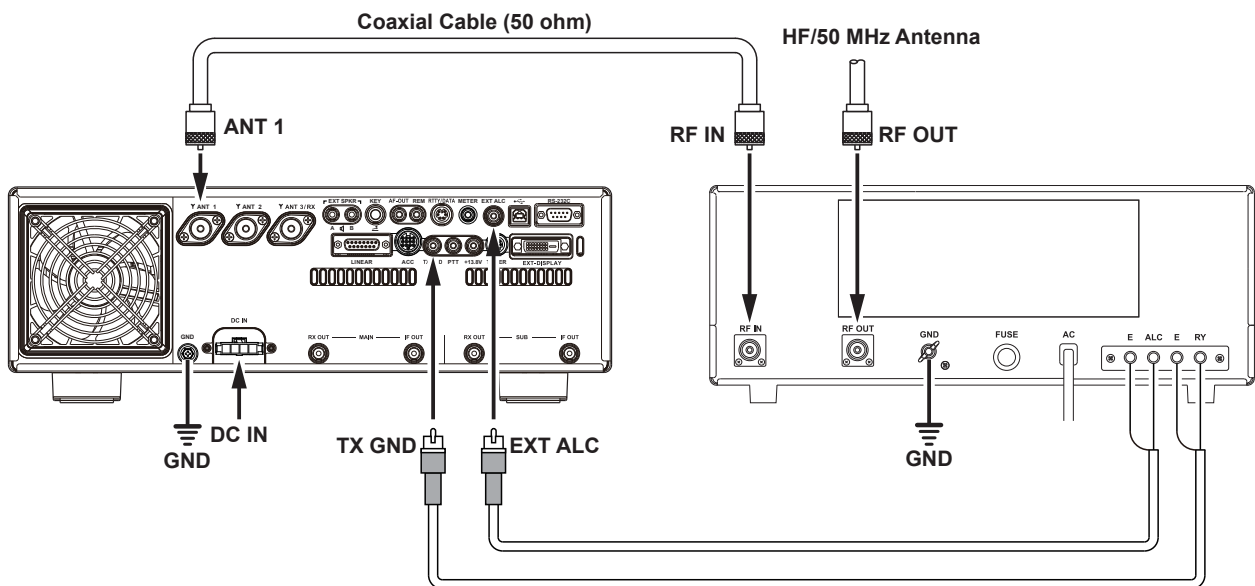

The figure above shows the FTDX101MP rear panel connections to other linear amplifiers.

Rear Panel

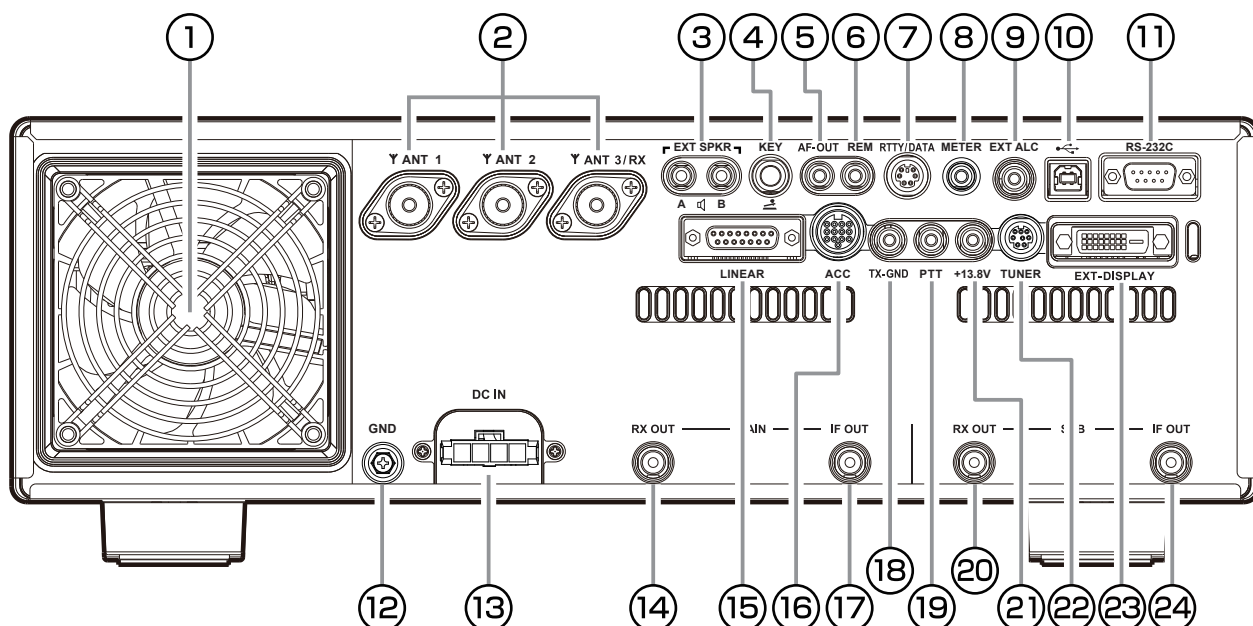

The figure above shows the rear panel of the FTDX101MP.

① Cooling FAN

② ANT 1, 2, 3/RX

Connect the main antenna(s) here, using type-M (PL-259) connectors and coaxial feed lines. The internal antenna tuner affects only the antenna(s) connected here, and only during transmission.

③ EXT SPKR

This 3.5-mm, 2-contact, jacks provide audio output for external loudspeakers. The impedances at the jacks are 4 - 8 Ohms, and the volume varies according to the setting of the front panel [AF] knob.



Inserting plugs into the jacks alters the internal loudspeaker configuration.

Depending on the plugs connected to the jacks, the configuration of the internal and external speakers varies.

	A	B	Internal Speaker
Connect to A only	MAIN and SUB audio	-	-
Connect to B only	-	MAIN audio	SUB audio
Connect to both A and B	SUB audio	MAIN audio	-

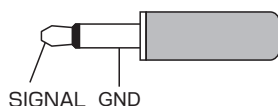

④ KEY

This 1/4-inch 3-contact jack accepts a CW key or keyer paddle. A two-contact plug cannot be used in this jack. Key-up voltage is +5.0 V DC, and key-down current is 3 mA.

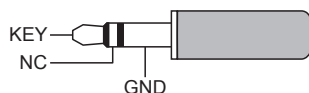

When connecting a single straight key

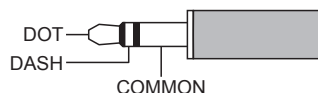

When connecting an electronic keyer paddle

⑤ AF-OUT

This 3.5-mm, 3-contact jack provides dual-channel low-level receiver output, for recording or external amplification.



The front panel [AF] knobs do not affect the signals at this jack (300 mVp-p at 10 k-ohms).



⑥ REM

By plugging the FH-2 Remote Control Keypad into this jack, direct access to the FTDX101 CPU is provided for control functions of the contest memory keying, and also frequency and function control.

⑦ RTTY/DATA

This 6-pin input/output jack accepts AFSK input from a Terminal Node Controller (TNC); it also provides fixed level receiver audio output, and FSK keying line.



⑧ METER

This 3.5-mm jack is to connect an external meter. The meter display is output as an analog voltage (0 V to about 3 V). Insert appropriate resistors in series according to the meter you use.

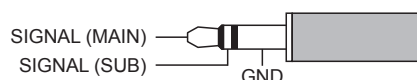

9 EXT ALC

This RCA input jack accepts negative-going external ALC (Automatic Level Control) voltage from a linear amplifier to prevent over-excitation by the transceiver. Acceptable input voltage range is 0 to -4 VDC.

10 USB

Connecting to a computer from this jack with a commercially available USB cable allows remote control by CAT commands from the computer. The jack can also be used for input and output of audio signals and transmitter control. A USB driver is required for remote control from a computer. Download the driver from the Yaesu website (<http://www.yaesu.com>).

11 RS-232C

This 9-pin serial DB-9 jack permits external computer control of the FTDX101. Connect a serial cable here and to the RS-232C COM port on your personal computer (no external interface is required).

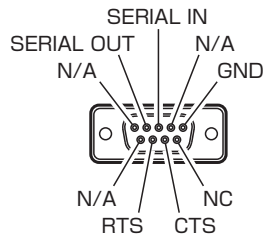

12 GND

Use this terminal to connect the transceiver to a good earth ground, for safety and optimal performance. Use a large diameter, short braided cable to make ground connections.

13 DC IN

This is the DC power supply connection for the transceiver.

FTDX101MP

Connect the supplied external power supply "FPS-101" using the supplied DC cable.

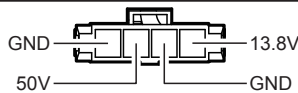

FTDX101D

Use the supplied DC cable to connect directly to a DC power supply, which must be capable of supplying at least 23 A @ 13.8 VDC.

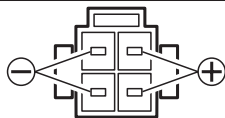

14 RX OUT (MAIN)

This RCA jack provides output of the RF signal. For connecting an external receiver and the like.

15 LINEAR

This 15-pin output jack provides band selection data, which may be used for control of optional accessories such as the VL-1000 Solid-state Linear Amplifier.

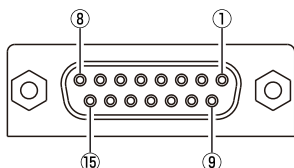

- | | | |
|---------------|---------------|-----------|
| ① +13.5V OUT | ⑥ BAND DATA C | ⑪ TX REQ |
| ② TX GND | ⑦ BAND DATA D | ⑫ NC |
| ③ GND | ⑧ TX INH | ⑬ NC |
| ④ BAND DATA A | ⑨ GND | ⑭ EXT ALC |
| ⑤ BAND DATA B | ⑩ NC | ⑮ GND |

16 ACC

This 13-pin jack may be connected to an external device.

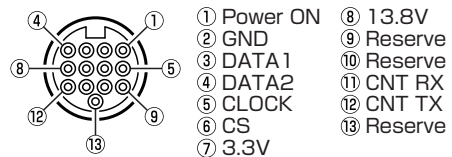

17 IF OUT (MAIN)

This RCA jack outputs the receiver 9.005 MHz IF signal. This signal does not pass through the roofing filter.

18 TX-GND

This RCA jack's center pin is closed to ground while the transceiver's transmitter is engaged. The transistor open collector circuit used for this jack is capable of switching a DC voltage of 60 V at 200 mA, or DC 30 V at up to 1Amp.

19 PTT

This RCA input jack may be used to provide manual transmitter activation using a foot switch or other switching device. Its function is identical to the [MOX] key on the front panel. Open-circuit voltage is 5 VDC, and closed-circuit current is 3 mA.

20 RX OUT (SUB)

This RCA jack provides output of the RF signal. For connecting an external receiver and the like.

21 +13.8V

This RCA output jack provides regulated, separately fused 13.8 VDC at up to 200 mA, to power an external device such as a packet TNC. Make sure your device does not require more current (if it does, use a separate power source).

22 TUNER

This 8-pin output jack is used for connection to the FC-40 External Automatic Antenna Tuner.

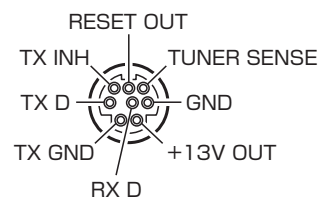

23 EXT-DISPLAY

DVI-D connector for connecting an external monitor. When using an external monitor, set the setting menu item "EXT DISPLAY" (page 105) to "ON".

! Connect a monitor that supports 800 x 480 resolution or 800 x 600 resolution.

24 IF OUT (SUB)

This RCA jack outputs the receiver 8.900 MHz IF signal. This signal does not pass through the roofing filter.

SSM-75G Microphone Switches

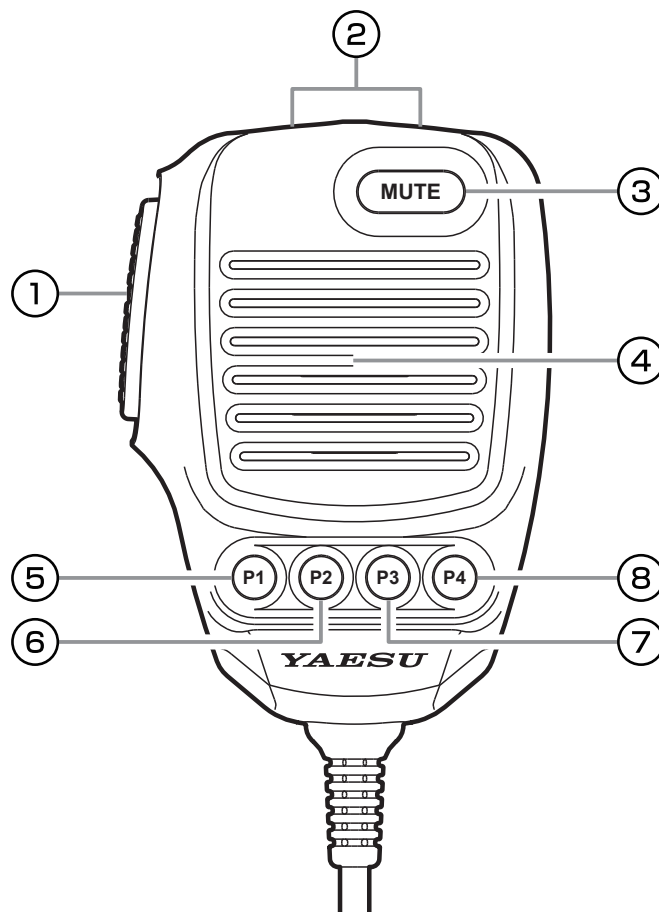

① PTT Switch

Switches Transmit/Receive.
Press to transmit and release to receive.

② DWN / UP Key

The [UP]/[DWN] keys may also be used to manually scan the frequency upward or downward.

- Pressing the [FAST] key engages the “Fast” tuning selection.
- The amount of frequency change depends on the operation mode (default setting: see table below).

Operating Mode	UP	DWN
CW / SSB / RTTY DATA-L / DATA-U / PSK	+10Hz [+100Hz]	-10Hz [-100Hz]
AM / FM DATA-FM	+5kHz [+50kHz]	-5kHz [-50kHz]

Numbers in parentheses indicate steps when the [FAST] key is On.

- The frequency change can be changed in the setting menu.

Operating Mode	Memu Item	Step
SSB / CW RTTY / PSK DATA-L DATA-U	SSB/CW DIAL STEP (page 103)	5/10 (Hz)
AM	AM CH STEP (page 103)	2.5/5/9/10/ 12.5/25 (kHz)
FM DATA-FM	FM CH STEP (page 103)	5/6.25/10/ 12.5/20/25 (kHz)

③ MUTE Key

While pressing the MUTE key, the receiver audio from the speaker will be muted.

④ Microphone

Speak into the microphone in a normal tone of voice with the microphone 5 cm away from the mouth.

⑤ P1 key

Switches the operation to the MAIN band.
It is the same function as the [MAIN] key on the front panel of the transceiver.

⑥ P2 key

Switches the operation to the SUB band.
It is the same function as the [SUB] key on the front panel of the transceiver.

⑦ P3 key

Switches transmission to the MAIN band.
It is the same function as the MAIN band [TX] key on the front panel of the transceiver.

⑧ P4 key

Switches transmission to the SUB band.
It is the same function as the SUB band [TX] key on the front panel of the transceiver.

Be sure to study this information to maximize the receiver performance of the high-class FTDX101 series shortwave transceiver.

Narrow band SDR receiver signal flow and the specific functions that affect receiver performance.

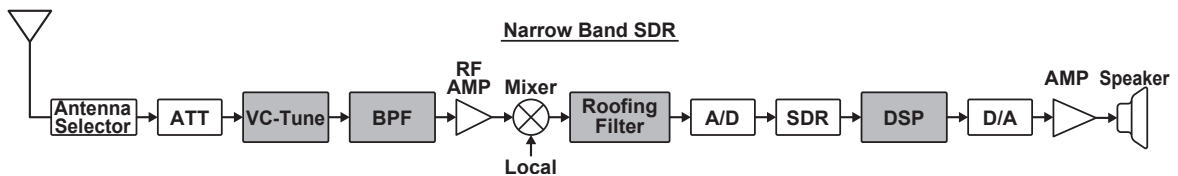

Received signal flow

Use the VC TUNE

VC-Tune can attenuate interfering signals directly at the receiving frequency. VC-Tune can be turned ON to attenuate the strong jamming signals that cannot be removed even with the BPF. If there is no disturbing signal, turn it OFF. Operation is performed with the outside MPVD ring of the Main Dial.

BPF (Band Pass Filter)

BPF is selected automatically. When a frequency band is selected on the front panel, the BPF (Band Pass Filter) for that band is automatically connected to the antenna circuit.

Use the ROOFING FILTER

Roofing filters attenuate strong signals that are outside of the desired passband after converting to the 9MHz IF.

The roofing filter can attenuate unwanted frequency components. Touch [R.FIL] on the TFT screen to select the 3kHz filter for SSB, the 1.2kHz filter or the 600Hz filter for CW. An optional 300Hz* filter is also available.

* Included with FTDX101MP.

Use DSP interference removal functions

DSP interference removal functions include IF SHIFT, IF WIDTH, IF NOTCH, APF, CONTOUR, and DNR.

Use these functions to adjust for comfortable reception while listening to the received audio.



To change the sound quality of the received audio, use the CONTOUR function to easily improve the sound quality with high and low frequency cut or emphasis.

Display Indications

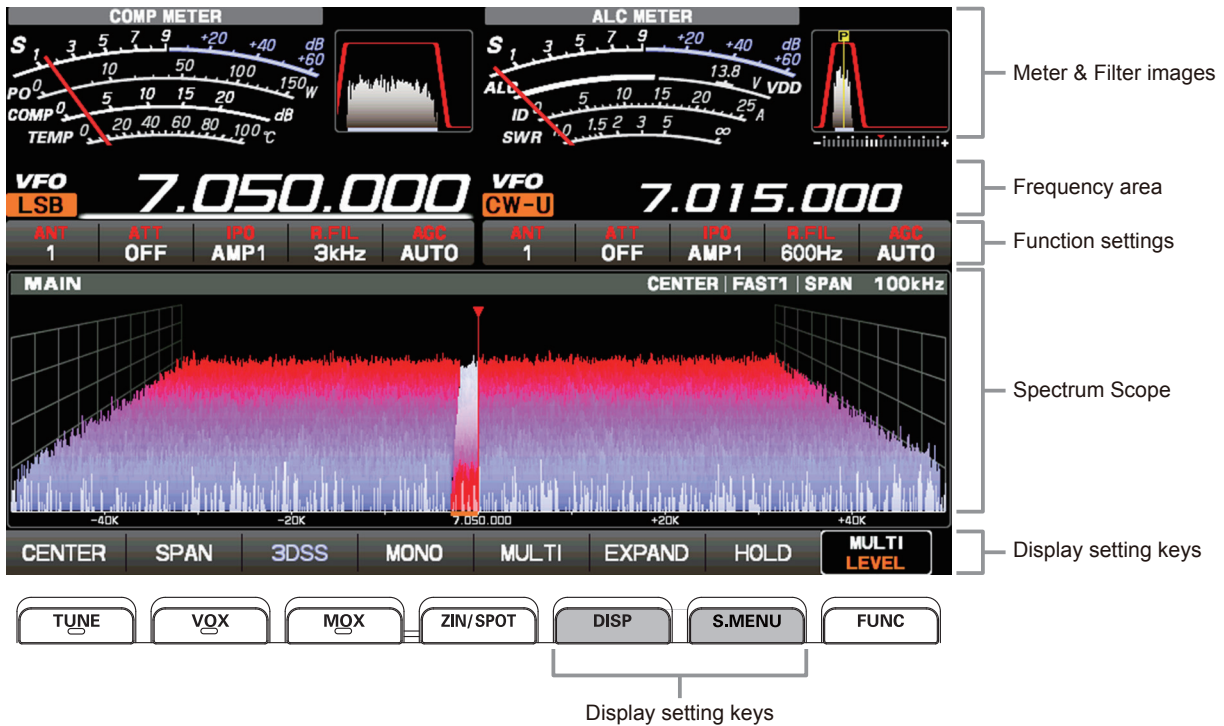

Meter Display

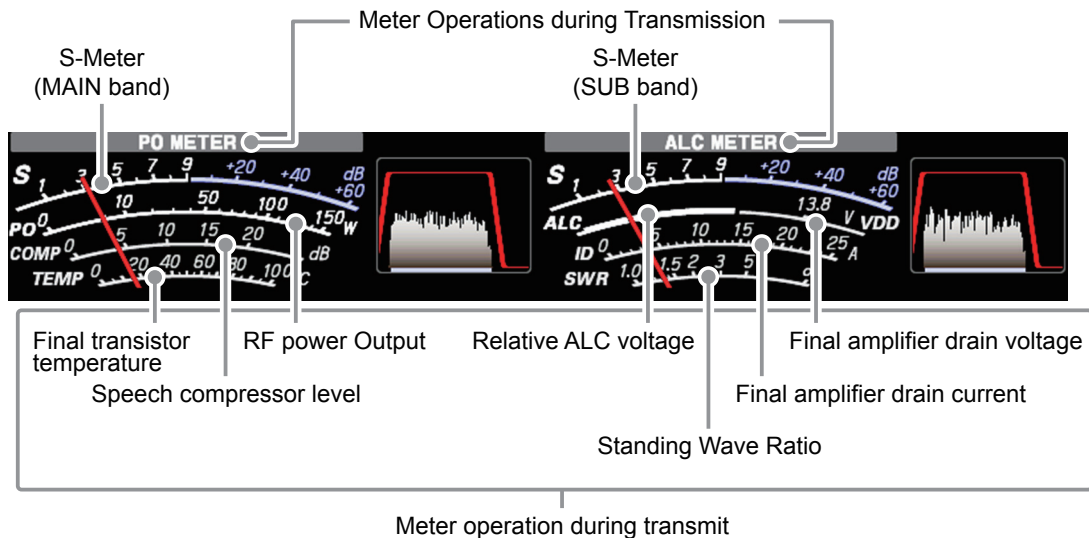

When the meter display screen is touched, the transmit meter selection screen is shown (the default default setting is "PO" on the left and "ALC" on the right).

AMC gain control display
 (Displays compression level during speech processor operation)
 Make adjustments with the [PROC / PITCH] control.

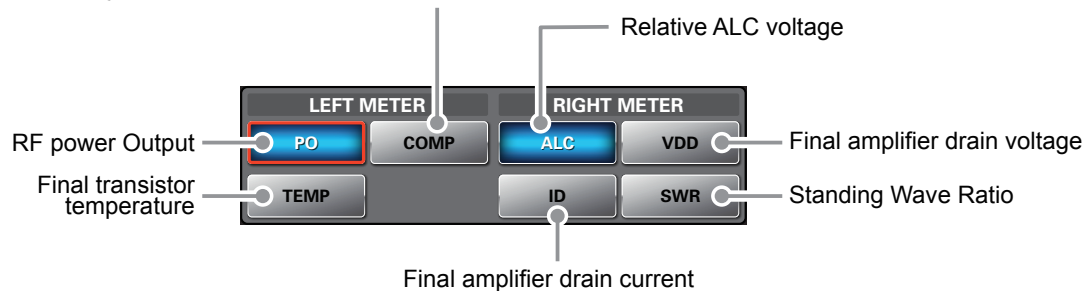

Filter Function Display

Displays the passband status of the DSP filter. The operation of WIDTH, SHIFT, NOTCH, CONTOUR etc. can be observed.

The current roofing filter bandwidth is displayed as a blue line below the filter function display.

The roofing filter is selected by touching [R. FIL].

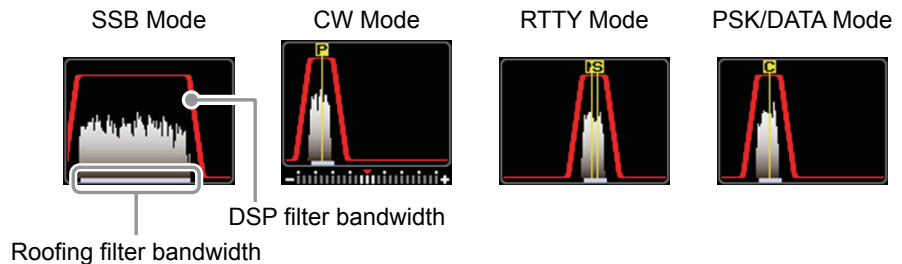

i Touch the filter function display to toggle between “normal display” and “magnified display”. Touch again to return to the “normal display”.

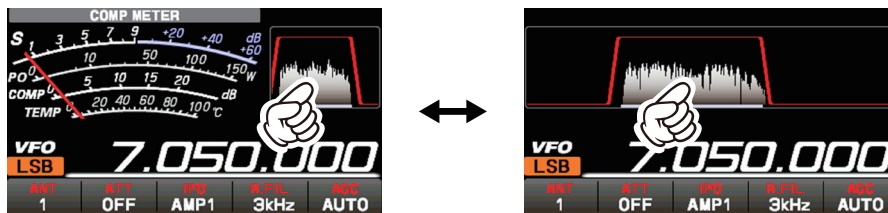

• Display only DSP filter bandwidth information

To display only the DSP filter bandwidth information, press and hold the spectrum area of the filter function display to clear the spectrum view. To display it, press and hold again.

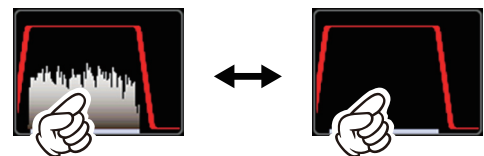

Frequency Display

The transmit and receive frequencies of the MAIN Band are shown on the left and the transmit and receive frequencies of the SUB Band are shown on the right.

In split operation, the transmit frequency is displayed in red.

• Keyboard Frequency Entry

1. Touch the “Hz” area of the frequency display.

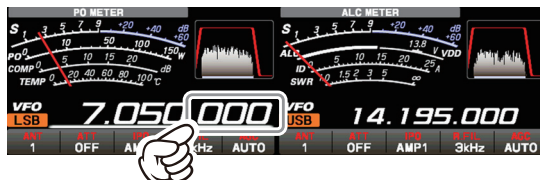

2. Enter the frequency using the numeric keys.

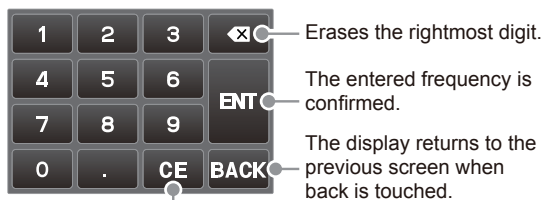

Clear all entered numbers.

• If there is no operation within 10 seconds, the input will be canceled.

3. Touch [ENT] to confirm.

• A short-cut for frequencies ending in zero - press the [ENT] key after the last non-zero digit.

Example:

To enter 7.00.000MHz

[0]→[7]→[ENT] or [7]→[.]→[ENT]

To enter 7.03.000MHz

[7]→[.]→[0]→[3]→[ENT]

• Tuning in 1 MHz or 1 kHz Steps

To temporarily set the dial knob to 1MHz or 1kHz steps, touch the “MHz” or “kHz” area of the frequency display.

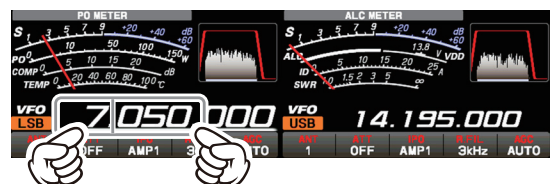

Touch “MHz” or “kHz” area of the frequency display to confirm. If there is no operation within 3 seconds, the frequency will be fixed.

i

- Touch the Frequency Display of the inactive band to change the Operating Band with one touch.
- Touch the Scope Screen, to easily move to the touched frequency.

Important Receiver Settings

The status of various operations that are important during receive, are shown at the bottom of the display. To change a setting, touch the appropriate location on the display.

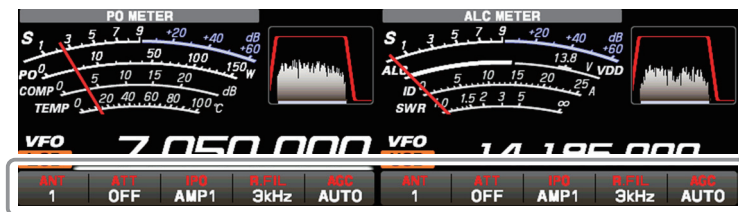

Important setting items when receiving

ANT (Switching the Antenna)

The currently used antenna terminal number (“ANT 1” “ANT 2” “ANT 3 / RX”) is displayed. After touching ANT, touch the desired number. The antenna can be set separately for each operation band.



The antenna terminal “ANT 3 / RX” can be set to “Receive Only” (Set Menu: “ANT 3 SELECT” page 97).

ATT (Attenuator)

Displays the current ATT (Amount of receive input signal attenuation).

When the desired signal is extremely strong or the noise level is high on a low frequency band, activate the attenuator to reduce the incoming signal or noise from the antenna.

After touching [ATT], touch the desired attenuation amount.

The attenuator is set independently for each operation band.

OFF	Attenuator is Off
6dB	The incoming signal power is reduced by 6dB (Signal voltage reduced to 1/2)
12dB	The incoming signal power is reduced by 12dB (Signal voltage reduced to 1/4)
18dB	The incoming signal power is reduced by 18dB (Signal voltage reduced to 1/8)

- If the noise level is high or the received signal is extremely strong, the incoming signal level can be suppressed with the IPO/ATT settings. If the S-meter fluctuates S-3 or more in the noise level, or the received signal is extremely strong and it causes a high S-meter indication (+20dB or more), activate the attenuator.
- Since IPO does not only attenuate the incoming signal, but also improves the cross modulation characteristic, try to activate the IPO first. If the signal is still strong, also use the ATT. In this way, you can attenuate the incoming signal and noise effectively.



IPO

The IPO (Intercept Point Optimization) function can establish the gain of the RF amplifier section to accommodate the connected antenna and the received signal conditions. IPO can be selected from three operating conditions.

AMP1: One stage RF amplifier is connected. This is a well-balanced operation of receiver sensitivity and characteristics (Approximately 10 dB gain).

AMP2: Two RF amplifiers are connected in series to give top priority to sensitivity (Approximately 20 dB gain).

IPO: The received signal is input to the IF mixer without passing through the RF amplifier. This can greatly improve receiving, especially in the harsh low band signal environment.

After touching [IPO], touch the desired operating condition.

- IPO is set independently for each operation band.
- Normally, select “AMP1”.
- The IPO can not only attenuate the input signal but also improve the intermodulation characteristics. It is most effective to operate the IPO first, and then use the ATT if the signal is still too strong. The noise level can be attenuated and S/N greatly improved.



R.FIL (Roofing Filter Switching)

Displays the bandwidth of the currently selected roofing filter.

Switches the crystal roofing filters of 300Hz*, 600Hz, 1.2kHz*, 3kHz, and 12 kHz that are installed in this transceiver.

Normally, filters are automatically switched depending on the operation mode, however the filter may be changed according to the conditions or when an optional filter is installed.

Roofing filters are to be set independently for each operation band.

* 300Hz & 1.2kHz roofing filters are optional. (300Hz is included on the MAIN side with the FTDX101MP)

After touching [R. FIL], touch the desired filter.

If the optional 300Hz and 1.2kHz filters are not installed, "300Hz" and "1.2kHz" will not be displayed.

AGC (Automatic Gain Control)

Displays the currently selected AGC setting.

The AGC system is designed to help compensate for fading and other propagation effects. The AGC characteristics can be individually set for each operating mode. The basic objective of AGC is to maintain a constant audio output level once a certain minimum threshold of signal strength is achieved.

After touching [AGC], touch the desired time constant.

- AGC can be set for each operation band.
- The "AUTO" selection mode selects the optimum receiver-recovery time for the reception mode.

Operating Mode	AUTO AGC Selection
SSB / AM	SLOW
CW / FM / DATA-FM	FAST
RTTY / PSK DATA-L / DATA-U	MID



Normally, AGC is set to "AUTO", which automatically selects the time constant according to the received signal type, but when receiving a weak signal or when there is noise and fading, the AGC action may be changed according to the reception condition at that time. Change the time constant to make received signals most audible



Several aspects of AGC performance may be configured via the Menu. However, because AGC can have such a profound impact on overall receiver performance, we generally do not recommend any changes to the AGC Menu selections until you are thoroughly familiar with the performance of the FTDX101.

Scope Display Setting

In addition to the conventional two-dimensional waterfall spectrum display, Yaesu has added the 3-Dimension Spectrum Stream (3DSS) color display. The constantly changing band conditions and signals are depicted in real time and color. The frequency span is shown on the horizontal X axis, the vertical Y axis depicts the signals and their strengths, and the time is represented on the receding Z axis. The FTDX101 operator can intuitively grasp the band and signal conditions at any instant.

! When VC Tune operates, the steep attenuation characteristics of VC Tune may cause some signals in the spectrum scope to be attenuated and disappear, or the screen may not look uniform, but this is not a malfunction.

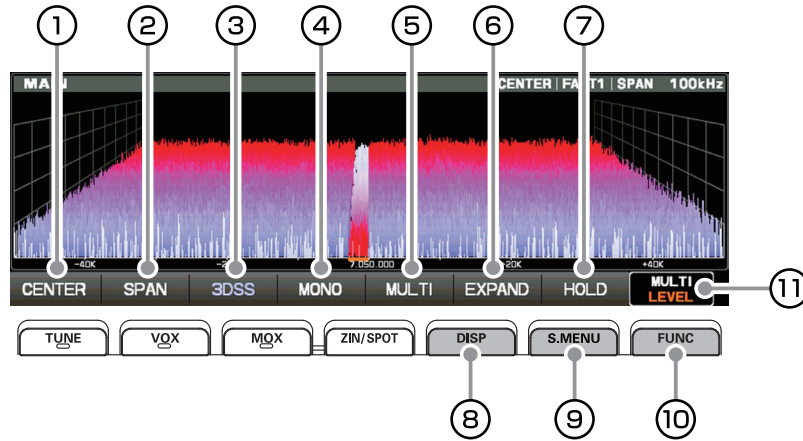

① CENTER/CURSOR/FIX

Switches the Spectrum Scope operation each time the key is touched.

- When the display area is touched, the receive frequency is moved to that point.
- In CENTER mode, the frequency touched becomes the center.
- In CURSOR and FIX mode, the marker and the receive frequency move to the touched position.
- Press and hold the [FAST] key in the CENTER and CURSOR modes, the Hz digit of the receive frequency will be "0".
- Press and hold the [FAST] key in FIX mode, the receive frequency returns to the start frequency of the display area.

• CENTER

The receive frequency is always shown at the center of the screen and spectrum display. The band spectrum is shown within the range set by "SPAN". The CENTER mode is convenient for monitoring the situation around the operating frequency.

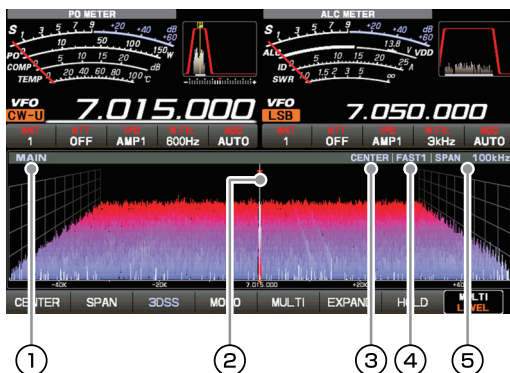

- ① MAIN or SUB
- ② Marker*
- ③ Current display mode (CENTER)
- ④ Sweep Speed
- ⑤ Scope Screen frequency span (display range).

*: At factory shipment, marker display is ON.

• CURSOR

Monitors the spectrum within the range set with "SPAN". When the frequency (marker) exceeds the upper limit or the lower limit of the range, the screen is automatically scrolled and the status outside the setting range can be observed.

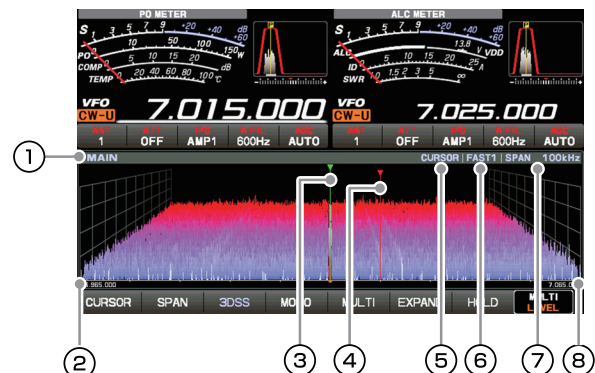

- ① MAIN or SUB
- ② The lower limit frequency of the display area.
- ③ Marker* (Receive Frequency)
- ④ Marker* (Transmit Frequency)
- ⑤ Current display mode (CURSOR)
- ⑥ Sweep Speed
- ⑦ Scope Screen frequency span (display range).
- ⑧ The upper limit frequency of the display area.

*: At factory shipment, marker display is ON.

• FIX

To use Fixed Mode, enter the start frequency of the scope.

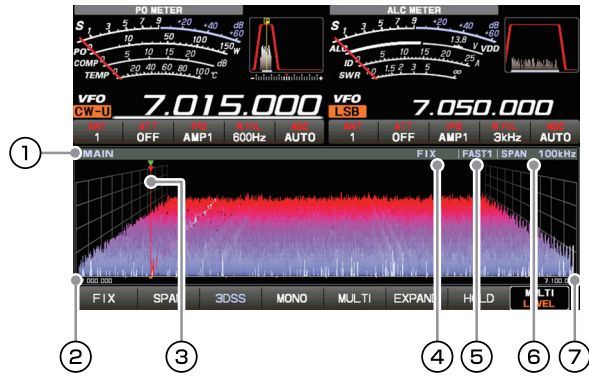

- ① MAIN or SUB
- ② Display area start frequency
- ③ Marker* (Reception Frequency)
- ④ Current display mode (FIX)
- ⑤ Sweep Speed
- ⑥ Scope Screen frequency span (display range).
- ⑦ The upper limit frequency of the display area.

*: At factory shipment, marker display is ON.

FIX is displayed at the top of the scope screen. Press and hold [FIX] while FIX is displayed, the frequency input screen will be displayed, and the start frequency can be entered:

Example:

To enter 7.000.000 MHz

[0] → [7] → [ENT] or [7] → [.] → [ENT]

To enter 7.030.000 MHz

[7] → [.] → [0] → [3] → [ENT]

i In FIX mode, If the [FAST] key is held, the receiver returns to the start frequency.

② SPAN

Set the frequency span (display range) of the scope screen. After touching, select the desired span.

i The display level changes when SPAN is changed, so reset the optimum display level with [LEVEL] each time.

③ 3DSS

Switch between the 3DSS display and the waterfall display.

The display will change each time it is touched:

i To adjust the level of the SUB band, press the [SUB] key to make the operation band a SUB band.

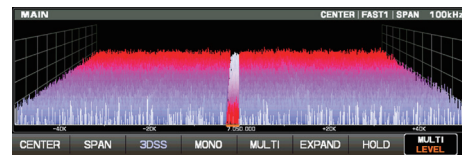

3DSS type

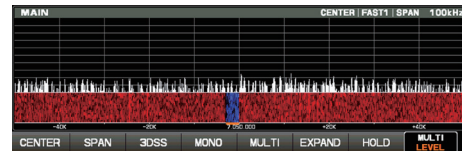

Waterfall type

Each time the Waterfall Display is touched, the size of the display changes as follows.

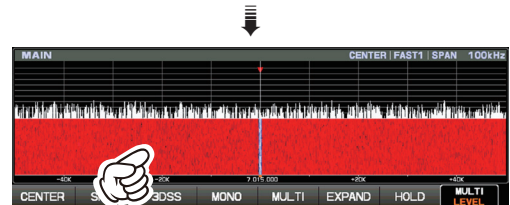
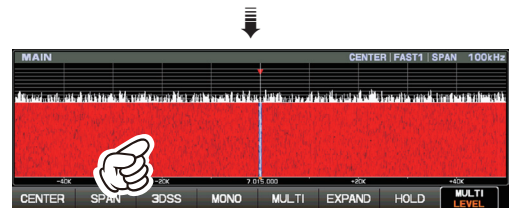
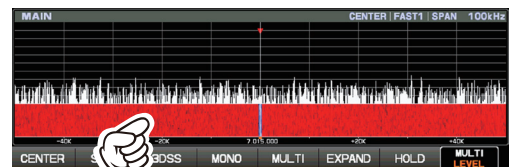

④ MONO (Dual/Mono Switching)

Touch to switch the display to "Mono" and show only the MAIN band.

Touch again to display both MAIN and SUB Bands.



Dual



Mono

5 MULTI

In addition to the scope display, the oscilloscope and AF-FFT are also presented.

Touch again to return to the original screen.

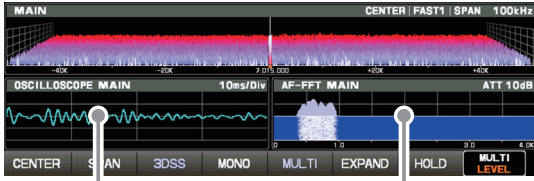

Touch this area to set the attenuator.

Touch this area to set the level and sweep speed.

6 EXPAND

The display area of the scope screen may be expanded vertically.

Touch to expand the display. Touch again to return to the original.

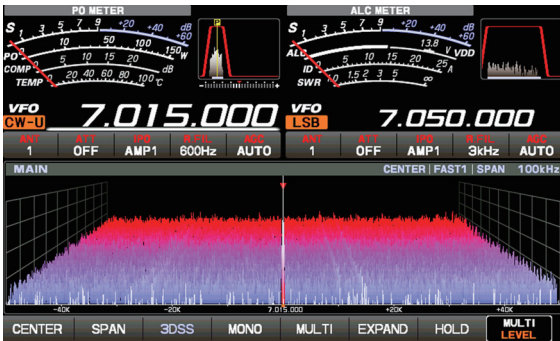

Normal Display

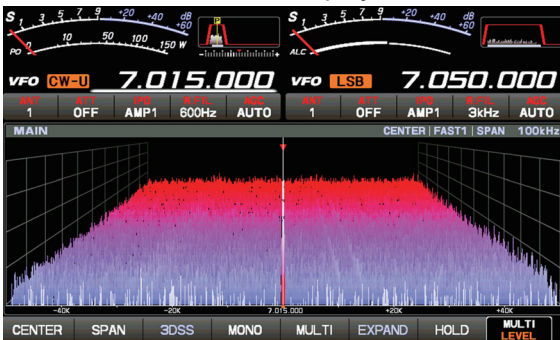

Larger View

7 HOLD

Temporarily stops the operation of the Scope Display and the Filter Function Display. Touch the display to enter HOLD state, touch it again to restore Scope operation.

During HOLD, "HOLD" flashes.

8 DISP

Each time the key is pressed, the Scope Screen Display changes as shown below.

Press the [SUB] key to adjust the SUB band reference level.

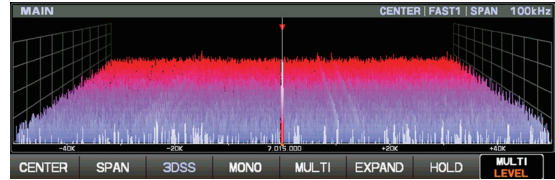

Only "MAIN" or "SUB" will be displayed

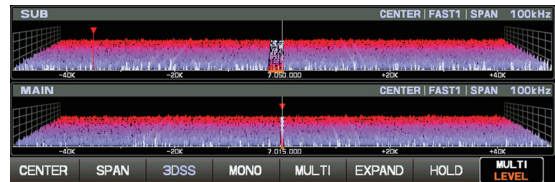

Upper side: SUB, Lower side: MAIN

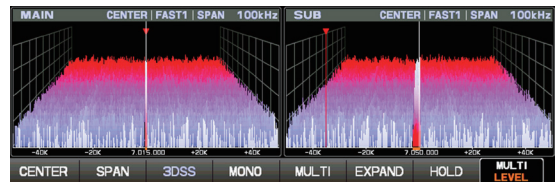

Left side: MAIN, Right side: SUB



Left side: MAIN, Right side: SUB

9 S.MENU

On the SCOPE MENU screen, enter settings related to the Scope Display. Press the [S.MENU] key to display the SCOPE MENU screen. Touch the desired item to set.

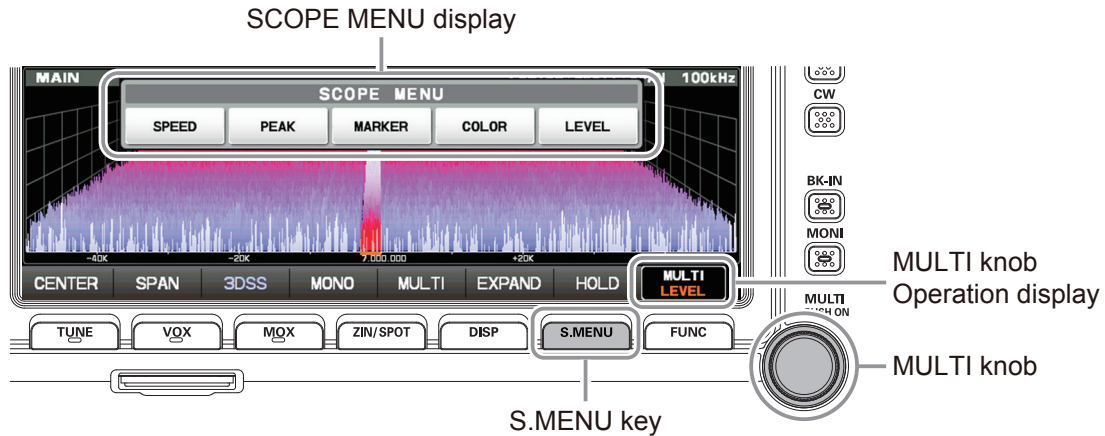

SPEED

Sets the Scope Display sweep speed. After touching, select the desired speed.

SLOW1:	sweep speed	Slow
SLOW2:	sweep speed	↑
FAST1:	sweep speed	Normal
FAST2:	sweep speed	↓
FAST3:	sweep speed	Fast

PEAK

The color density may be adjusted to the level of the signal. Touch PEAK and then select the desired color concentration.

LV1:	Thin
LV2:	↑
LV3:	Normal
LV4:	↓
LV5:	Dark

MARKER

Displays markers that indicates the position of the current receive and the transmit frequencies in the spectrum. Normally leave it ON.

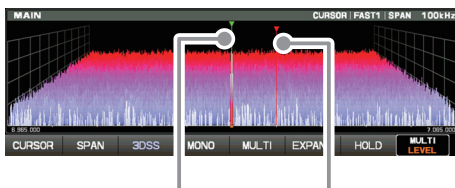

Receive Frequency Transmit Frequency

COLOR

Touch COLOR and select the desired color from the Display Color selection panel. The screen panel will disappear automatically after about 3 seconds. The color to be displayed for the Direct Sampling SDR, and for the Narrow Band SDR can be changed on the Color Selection Panel.

1. Press the [S.MENU] key to display the SCOPE MENU.
2. Touch [COLOR].
3. Touch the desired color from the selections on the screen.

To change the color of the Narrow Band SDR, touch and desired color block.

Favorite color combinations can be registered in the menu by pressing and holding M-1, M-2 or M-3. Even when the color is not changed, the Narrow Band SDR information is displayed.

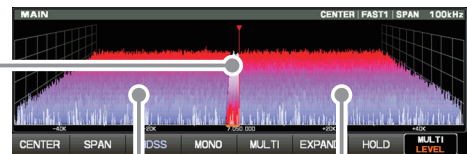

Overall setting area

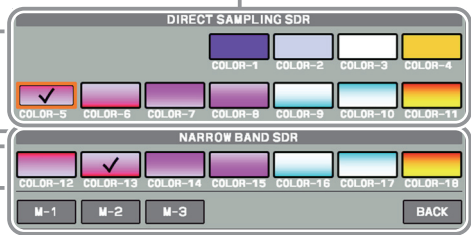

Narrow band SDR setting area

LEVEL

Adjust the level to make it easier to distinguish between the desired signal and noise. The display level changes depending on antenna gain, condition, frequency band, SPAN and so on.

Always adjust the LEVEL for the best image on the screen.

Touch LEVEL, and then turn the [MULTI] knob to select the desired level.

- On the 3DSS screen, weak signals may be more easily observed by adjusting the LEVEL so that the noise level can be seen only a little, so always adjust the LEVEL and use it at the optimum position.
- Be sure to make adjustments when changing bands or changing SPAN.
- If the level is changed, the signal strength also appears to change, but it does not affect the actual signal input level.

⑩ Function Menu Display

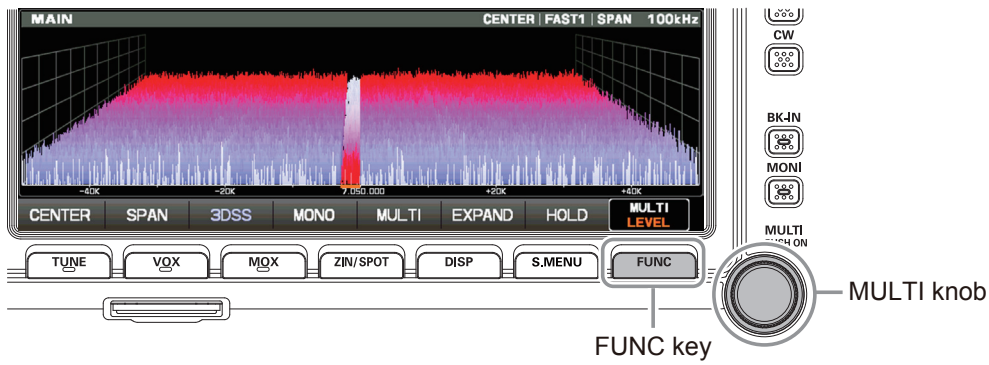

Press the [FUNC] key to call up the function screen for setting various functions. The setting menu (page 88) is also called from the function screen. Press again to return to the normal operation screen. Touch a MENU item, or rotate the [MULTI] control knob to make a selection.



⑪ Operation of the Display MULTI Knob



[MULTI] displays the operation of the [MULTI] knob.

Normally, it is recommended to adjust the level of the spectrum scope as the [LEVEL] knob control of [S.MENU]. The last function used is stored in the [MULTI] control, it can easily set by operating the [MULTI] control.

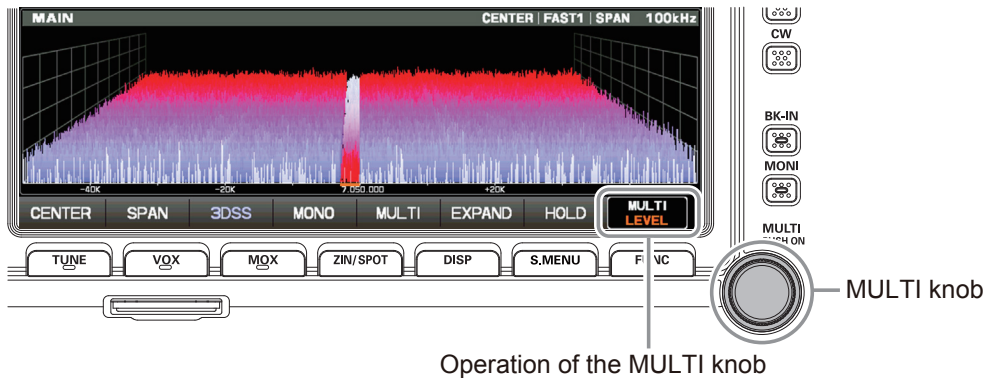

Operation of the MULTI knob

The following settings and operations can be performed with the [MULTI] control.

SPEED*: Set Scope Sweep Speed.
PEAK*: Adjust the Peak Signal Color Density.
MARKER*: ON/OFF Marker indicates the transmit and receive frequency position within the Scope Display image.
COLOR*: Changes the scope display color.
LEVEL*: Adjust the reference level to make it easier to distinguish the scope display target signal from the noise.

*These items may be called up by pressing the [S.MENU] key.

RF POWER: Transmit power setting
MONI LEVEL: Monitor level adjustment
DNR LEVEL: DNR level setting
NB LEVEL: Noise blanker level setting
VOX GAIN: VOX gain setting
VOX DELAY: VOX delay setting
ANTI VOX: Anti-VOX Settings
STEP DIAL: Frequency change at predetermined frequency step
MEM CH: Memory channel selection
GROUP: Memory group selection
R. FIL: Roofing filter bandwidth selection

Other On-Screen Indications

BUSY:	Lights up while receiving a signal.	M-xx:	Displays the selected channel number in memory mode.
TX:	Lights up during transmission.	MT:	Lights up during memory tuning operation.
+ :	Lights in plus shift (repeater operation).	QMB:	Lights up during operation with quick memory.
-:	Lights in negative shift (repeater operation).	PMS:	Lights up during programmable memory scan operation.
ENC:	Lights when the tone encoder is operating.	EMG:	Emergency call set frequency call lights up.
TSQ:	Lights during tone squelch operation.	LSB / USB / CW-L / CW-U / AM / AM-N / FM / FM-N / DATA-L / DATA-U / DATA-FM / D-FM-N / RTTY-L / RTTY-U / PSK:	Displays the selected radio emission type.
CLAR TRX:	Lights when the TRX clarifier is in operation.		
CLAR TX:	Lights up during TX clarifier operation.		
CLAR RX:	Lights up during RX clarifier operation.		
+ xxx Hz /-xxx Hz:	Displays the offset amount of the clarifier.		
HI-SWR:	A warning display to indicate an antenna system error.		
VFO:	Lights in VFO mode.		

About TFT Displays

FTDX101 series utilizes a TFT liquid-crystal display.

Although TFT liquid-crystal displays are made using very precise technology, they are prone to develop dead pixels (dark dot) or pixels that are always on (bright dot). Please understand that such phenomena do not constitute product defects or malfunctions. Rather, this phenomena occurs due to limitations in the manufacturing technology with respect to TFT liquid-crystal displays.

- Depending on the viewing angle, unevenness in color or brightness may occur. Please note that any unevenness observed is inherent to the construction of TFT liquid crystal displays and therefore does not constitute a product defect or malfunction.
- If your TFT liquid-crystal display becomes dirty, please use a dry soft cloth or tissue to wipe the display clean. Use of glass cleaner, household cleaners, organic solvents, alcohol, abrasives, and/or like substance may damage the TFT liquid-crystal display.

Screen Saver

A Screensaver, to prevent burning of the TFT screen will operate after a set time, if no transceiver function is operated.

1. Press the [FUNC] key.
2. Select [DISPLAY SETTING] → [DISPLAY] → [SCREEN SAVER].
3. Select the time until the screen saver is employed (default setting is 60 min).

OFF	Screensaver is not employed.
15min	Screensaver activates after 15 minutes.
30min	Screensaver activates after 30 minutes
60min	Screensaver activates after 60 minutes

4. Press the [FUNC] key to save the new setting and exit the Setting Menu.
5. Press the [FUNC] key to exit to normal operation.

Adjust contrast

Adjust the contrast of the TFT display.

1. Press the [FUNC] key.
2. Select [DISPLAY SETTING]→[DISPLAY]→[TFT CONTRAST].
3. Turn the [MULTI] knob to adjust the contrast (default setting is 10).
4. Press the [FUNC] key to save the new setting and exit the Setting Menu.
5. Press the [FUNC] key to exit to normal operation.

Adjusting the brightness (Dimmer)

Adjust the brightness of the TFT display and LED indicators.

1. Press the [FUNC] key.
2. Select [DISPLAY SETTING]→[DISPLAY].
3. Select the item whose brightness you want to adjust.

TFT DIMMER	Display (default 15)
LED DIMMER	LED indicators (default 10)

4. Turn the [MULTI] knob and adjust the brightness.
5. Press the [FUNC] key to save the new setting and exit the Setting Menu.
6. Press the [FUNC] key to exit to normal operation.

Font setting for frequency display

The height of the frequency display can be varied.



BOLD (Default)



LIGHT

1. Press the [FUNC] key.
2. Select [DISPLAY SETTING]→[DISPLAY]→[FREQ STYLE].
3. Select "LIGHT" or "BOLD".
4. Press the [FUNC] key to save the new setting and exit the Setting Menu.
5. Press the [FUNC] key to exit to normal operation.

Inputting the Call Sign

Registered call signs names, and characters can be displayed on the opening screen when the power is turned ON.

1. Press the [FUNC] key.
2. Select [DISPLAY SETTING] →[DISPLAY] → [MY CALL].
3. Touch a character key. The touched character will be displayed at the top of the screen. Enter each character of your call sign. Up to 12 characters (letters, numbers, and symbols) can be entered.



Caps	The input switches between lower and upper-case letters each time this symbol is touched.
⌫	One character to the left of the cursor is erased when this symbol is touched.
BACK	The display returns to the previous screen when this symbol is touched.
⬅️ / ➡️	The cursor in the input field moves left or right when these symbols are touched.
Space	Insert space
ENT	The entered characters are confirmed and the display returns to the previous screen when this symbol is touched.

4. Touch [ENT] .
5. Press the [FUNC] key to save the new setting and exit the Setting Menu.
6. Press the [FUNC] key to exit to normal operation.

Front Panel Controls & Switches

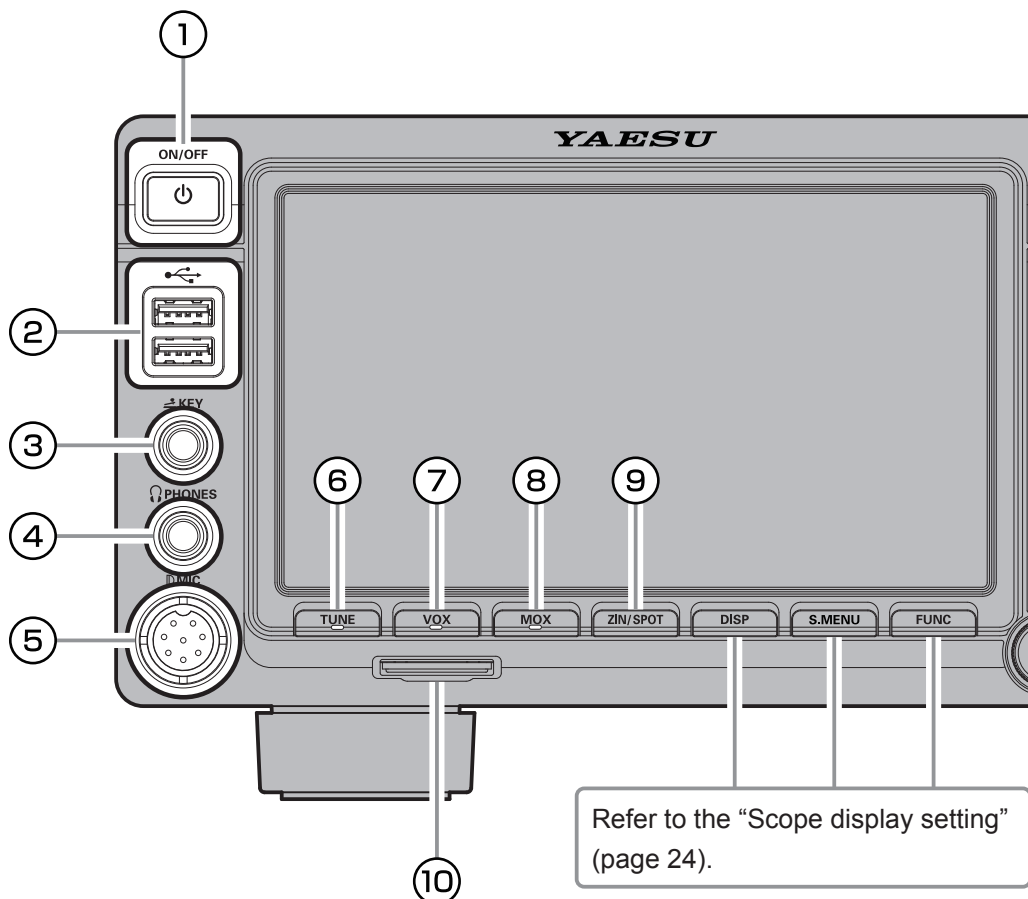

① ON/OFF Switch

Press and hold this switch for one second to turn the transceiver ON or OFF.

② USB Jack

Connect a USB A type keyboard or mouse. They can be used to select items on the screen or to enter characters.

③ KEY

Connect a telegraph key or electronic keyer paddle to use for CW mode operation.



When connecting a key or other device to the KEY jack, use only a 3-contact (“stereo”) 3.5 mm phone plug; a 2-contact plug will place a short between the ring and the (grounded) shaft of the plug, resulting in a constant “key-down” condition.

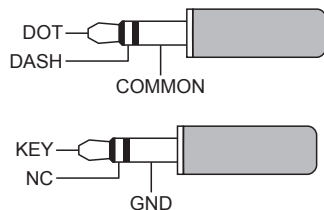

Key-up voltage is approximately +3.3 V DC, and key-down current is approximately 1 mA.

④ PHONES Jack

Connect headphones to this standard $\phi 6.3$ stereo jack.

Inserting a headphone plug into this jack will deactivate the internal and external speakers.



When wearing headphones, we recommend that you turn the AF Gain levels down to their lowest settings before turning power ON, to minimize the impact on your hearing caused by audio “pops” during switch-on.



⑤ MIC

This 8-pin jack accepts input from a microphone utilizing the traditional YAESU HF transceiver pinout.

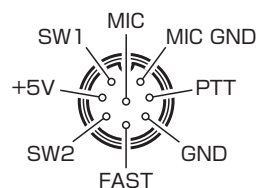

⑥ TUNE

This is the ON/OFF switch for the FTDX101 Automatic Antenna Tuner.

Press the [TUNE] key briefly to activate the antenna tuner. Press the [TUNE] key briefly again to disable the antenna tuner.

Press the [TUNE] key for about 1 second to start "automatic tuning".



Since the transceiver transmits automatically during automatic tuning, make sure to connect an antenna or dummy load before tuning up.



When the antenna or dummy load does not match the impedance, "HI-SWR" will appear on the touch panel.

⑦ VOX

This key enables automatic voice-actuated transmitter switching. While VOX is activated, the LED inside this key glows orange.

1. Press the [VOX] key. VOX feature is activated.
2. Without pressing the PTT switch, speak into the microphone in a normal voice level. When you start speaking, the transmitter should be activated automatically. When you finish speaking, the transceiver should return to the receive mode (after a short delay).

To cancel VOX and return to PTT operation, press the [VOX] key once more.

• Adjusts the VOX GAIN

The VOX Gain may be adjusted to prevent unintended transmitter activation in a noisy environment. To adjust the VOX Gain:

1. Press the [FUNC] key.
2. Touch [VOX GAIN].
3. While speaking into the microphone, rotate the [MULTI] knob to the point where the transmitter is quickly activated by your voice, without background noise causing the transmitter to activate.

• Adjusts the VOX Delay Time

The "Hang-Time" of the VOX system (the transmit-receive delay after the cessation of speech) may also be adjusted.

To set a different delay time:

1. Press the [FUNC] key.
2. Touch [VOX DELAY].
3. Rotate the [MULTI] knob while saying a brief syllable like "Ah" and listening to the hang time for the desired delay.

• Adjusts the VOX anti-trip sensitivity

The Anti-Trip setting sets the negative feedback of receiver audio to the microphone, to prevent receiver audio from activating the transmitter (via the microphone).

1. Press the [FUNC] key.
2. Touch [ANTI VOX].
3. Rotate the [MULTI] knob to prevent receiver audio from activating the transmitter (via the microphone).

⑧ MOX

Pressing this key engages the PTT (Push to Talk) circuit to activate the transmitter.

⑨ ZIN/SPOT

ZIN

Press the [SELECT] switch momentarily to adjust the receiving frequency and zero-in automatically while receiving a CW signal.

SPOT

While pressing and holding [SPOT], the tone is output from the speaker. This tone corresponds to the pitch of your transmitted signal. If you adjust the receiver frequency until the pitch of the received CW signal matches that of the Spot tone, the transmitted signal will be precisely matched to that of the other station.

⑩ SD memory card slot

You can use the commercially available SD memory card to save various settings, save the memory contents, screen capture and update the firmware.



- The SD card is not provided with the product.
- Not all SD cards sold commercially are guaranteed to work with this transceiver.

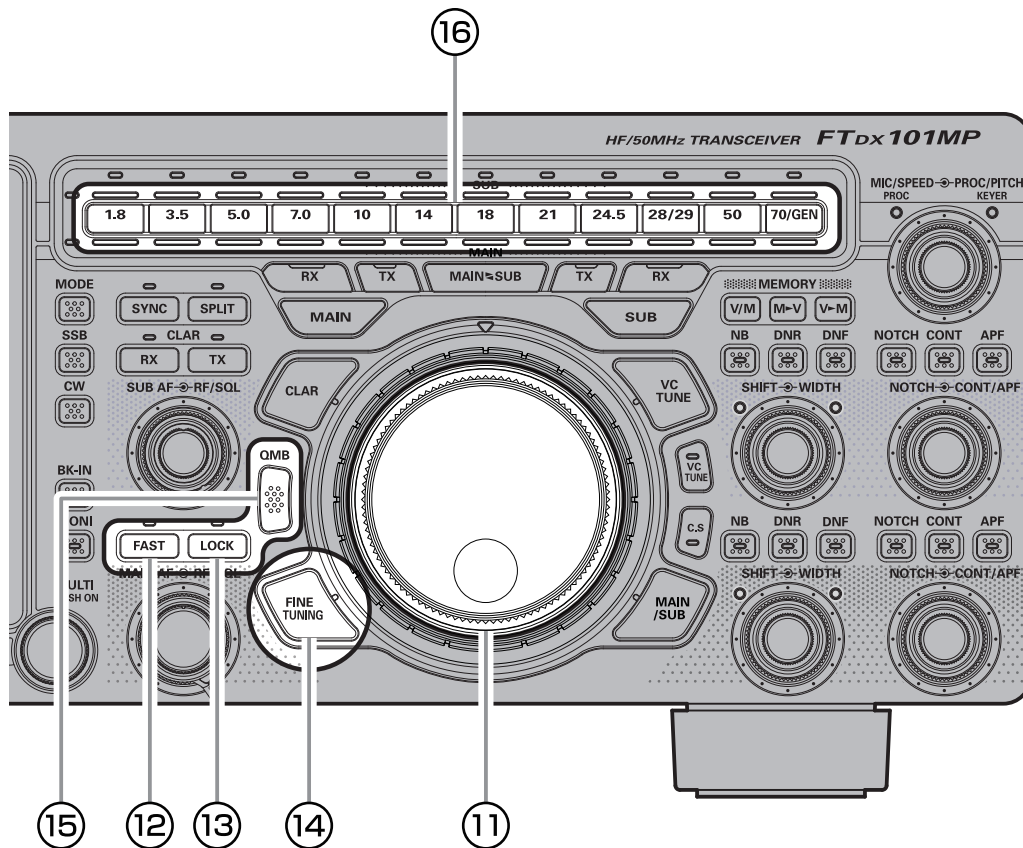

11 MAIN dial

The MAIN dial sets the operating frequency. Rotate the MAIN dial knob to tune within the band, and begin normal operation.

- Pressing the [FAST] key engages the “Fast” tuning selection.
- The amount of frequency change depends on the operation mode (default setting: see table below).

Operating Mode	1 Step	1 Dial Rotation
LSB / USB / CW DATA-L / DATA-U RTTY / PSK	10 Hz* (100 Hz)	5 kHz (50 kHz)
AM / FM DATA-FM	100 Hz (1 kHz)	50 kHz (500 kHz)

Numbers in parentheses indicate steps when the [FAST] key is On.

*This setting may be changed to 5 Hz in Setting Menu.

SSB/CW mode

“SSB/CW DIAL STEP” (page 103)

RTTY/DATA mode

“RTTY/PSK DIAL STEP” (page 103)

Adjusting the Main tuning DIAL torque

The torque (drag) of the Main DIAL knob may be adjusted for operating preferences. Slide the lever on the bottom side of the transceiver clockwise to reduce the drag, or counter-clockwise to increase the drag.

12 FAST

Pressing this key will change the tuning of the MAIN Dial knob and [MULTI] knob (When STEP DIAL function is assigned) to a higher step rate.



In Spectrum Scope FIX mode, a long press makes the receiver frequency the start frequency with one touch.



When FINE TUNING is activated, the amount of frequency change of the Main dial does not become a higher step rate.

13 LOCK

This key toggles the ON/OFF lock for the MAIN Dial knob. When “Lock” is ON, the MAIN Dial knob can still be turned, but the frequency will not change, and “MAIN LOCK” appears in the frequency display.

14 FINE TUNING (Tuning of 1 Hz)

In the SSB, CW, RTTY, PSK, DATA-L or DATA-U mode, the frequency can be adjusted in 1 Hz steps.

- The AM, FM, DATA-FM modes may be adjusted in 10 Hz steps.

1. Press the [FINE TUNING] key.
2. Rotate the MAIN dial knob.



While FINE TUNING is operating, the MAIN dial frequency change will not be 10 times faster, even if the FAST function is activated.

15 QMB (Quick Memory Bank)

The current operation status can be stored in a dedicated memory channel (QMB: Quick Memory Bank) with one touch.

• QMB Channel Storage

The current operation state can be memorized in a dedicated memory channel (QMB: Quick Memory Bank) with one touch.

i The initial number is 5 QMB memories, but this can be increased to 10 channels.

1. Tune to the desired frequency on the MAIN band.
2. Press and hold the [QMB] key. The “beep” will confirm that the MAIN band contents have been written to the currently available QMB memory.

i

- Repeated pressing and holding of the [QMB] key will write the VFO contents to successive QMB memories.
- Once all five (or ten) QMB memories have data on them, previous data will be over-written on a first-in, first-out basis.

• QMB Channel Recall

1. Press the [QMB] key.
The current QMB channel data will be shown on the frequency display area.
The “VFO” or “Memory Channel number” will be replaced by “QMB”.
2. Repeatedly pressing the [QMB] key will step through the QMB channels:
3. Press the [V/M] key to return to the VFO mode.

• Confirm the contents of QMB

You can display the contents memorized in QMB on the screen to check the data.

1. Press the [FUNC] key.
2. Touch “QMB LIST”, the QMB list will be displayed.

QMB LIST				
1	3 550.000	LSB		BACK
2	21.150.000	USB		
3	14.195.000	USB		
4	7.050.000	LSB		
5		DELETE

i On the list display screen, select the channel you want to delete, and then touch “DELETE” to clear the selected QMB.

• Changing the number of QMB channels

The QMB channels can be changed from “5 channels” or “10 channels”.

1. Press the [FUNC] key.
2. Select [OPERATION SETTING] → [GENERAL] → [QMB CH].
3. Select “5ch” or “10ch”.
4. Press the [FUNC] key to save the new setting and exit the Setting Menu.
5. Press the [FUNC] key to exit to normal operation.

16 BAND (Operating Band Selection)

Press the BAND key corresponding to the Amateur band that you wish to operate. The Indicator of the MAIN band lights “White”, and the SUB band lights “Blue”.

During transmit the indicator will light in “Red” to designate which band is transmitting.

Example: Setting the MAIN band to 7 MHz, and setting the SUB band to 21MHz.

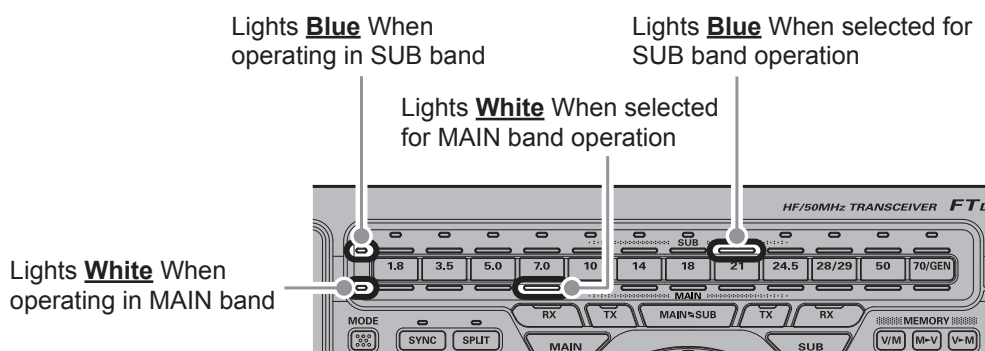

• Mark the operation band

Press and hold the desired band key, the orange Band Indicator will light. Press and hold the key again to turn the Indicator OFF.

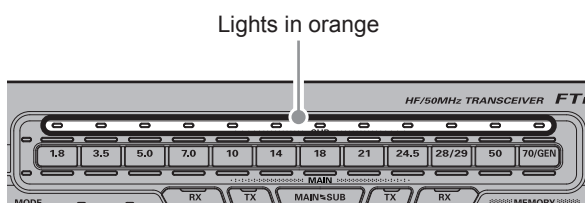

i

- The Band Indicator may be used to designate a connected antenna, a DXpedition, or contest operation band. Use it instead of MEMO.
- More than one band may be marked at the same time.

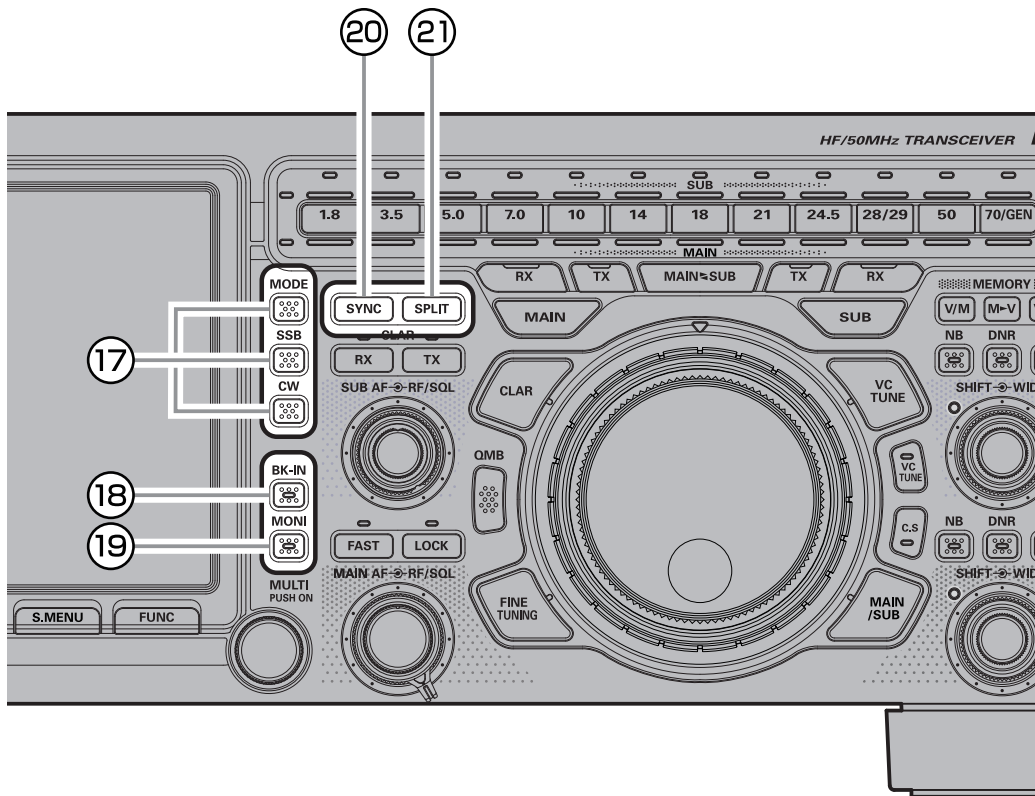

17 MODE/SSB/CW

Switch the operating mode.
Press and hold the [MODE] key, then touch the desired operating mode.
Press it briefly to set the previously selected operating mode.

MODE			
LSB	USB	CW-L	CW-U
AM	AM-N	FM	FM-N
DATA-L	DATA-U	DATA-FM	D-FM-N
RTTY-L	RTTY-U	PSK	

Pressing the [SSB]/[CW] key repeatedly will toggle to the alternate mode.

In the LSB or USB mode, pressing the [SSB] key toggles between "LSB" and "USB" mode.

In the CW-L or CW-U mode, pressing the [CW] key toggles between "CW-L" and "CW-U" mode.

[SSB] key

USB → LSB → USB →

[CW] key

CW-U → CW-L → CW-U →

When changing modes from SSB to CW, the display frequency will shift on the display, even though the actual tone that is heard does not change.



This shift represents the BFO offset between the "zero beat" frequency and the audible CW pitch (tone). The pitch is programmed via Menu item "CW FREQ DISPLAY" page 94).

18 BK-IN

This key turns the CW break-in capability ON or OFF. While CW break-in is activated, the LED inside this key glows orange.

19 MONI

Use the Monitor feature to listen to the quality of your transmitted signal. While activated, the LED inside this key glows orange.

1. Press the [MONI] key.
Monitor feature is activated.
When transmitting, the audio (side tone when in CW operation) is heard from the speaker.
2. Press and hold the [MONI] key and adjust the Monitor level with the [MULTI] knob.



Transmit audio monitor is not activate in the FM, DATA-FM and D-FM-N modes.

- If you are using the speaker for monitoring, instead of headphones, excessive advancement of the Monitor level can cause feedback to occur. Additionally, this feedback can cause the VOX system to hang up in a loop, making it impossible to return to receive. Therefore, we recommend the use of headphones, if at all possible, or the minimum usable setting of the Monitor level, if the speaker must be used.
- 3. To switch the Monitor OFF again, press the [MONI] key once more.
- Because the Monitor feature samples the transmitter IF signal, it can be very useful for checking the adjustment of the Speech Processor or Parametric Equalizer on SSB, and for checking the general signal quality on AM.

20 SYNC

Change the frequency of the MAIN band with the MAIN dial, the frequency of the SUB band also changes in the same step. If you press and hold for a while, the SUB band frequency will be the same as the MAIN band.

When this key is pressed and held, the frequency of the SUB band becomes the same frequency as the MAIN band.

21 SPLIT

A powerful capability of the FTDX101 is its flexibility in Split Frequency operation using the MAIN band and SUB band frequency registers. This makes the FTDX101 especially useful for high-level DX-peditions. The Split operation capability is very advanced and easy to use.

1. Set the MAIN band frequency to the desired receive frequency.
2. Press the [SUB] key.
3. Set the SUB band frequency to the desired transmit frequency.
4. Press the [MAIN] key, then press the [SPLIT] key.

The LED indicators will appear as shown below:

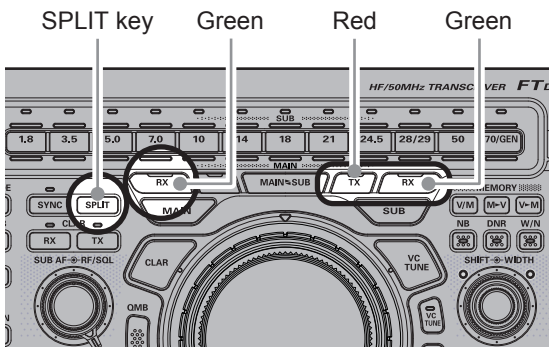

During Split operation, the MAIN band register will be used for reception, while the SUB band register will be used for transmission. If you press the [SPLIT] key once more, Split operation will be cancelled.

- During Split operation, pressing the [MAIN] key will reverse the contents of MAIN band and SUB band. Press the [MAIN] key once more to return to the original frequency settings.
- The receive and transmit frequencies can be set to different bands or operation modes.
- When transmitting and receiving in the MAIN band, if you press this, the transmission frequency will be the frequency of the SUB band and the frequency of the SUB band and the SUB band frequency display will be red.

Press and hold to increase the SUB band transmission frequency by 5 kHz.

- [SYNC] key
The [SYNC] key can move the frequencies of the MAIN band and SUB band simultaneously. Press and hold to adjust the SUB band frequency to the MAIN band frequency.

• Quick Split Operation

The Quick Split feature allows setting a one-touch offset of +5 kHz as compared to the MAIN band frequency, to be applied to the transceiver SUB band (transmit) frequency.

1. Start with regular transceiver operation on the MAIN band.
 2. Press and hold the [SPLIT] key to engage the Quick Split feature, which applies a frequency 5 kHz above the MAIN band frequency to the SUB band frequency register.
 3. Press and hold in the [SPLIT] key to increment the SUB band frequency another +5 kHz.
- The offset of SUB band from MAIN band is programmed via the Menu and is set to +5 kHz at the factory.
 - However, other offsets may be selected using menu item [QUICK SPLIT FREQ] (page 98).

• Direct input of offset frequency

The offset can be set to a frequency other than 5 kHz with the on-screen keyboard.

1. Set the MAIN band frequency to the desired receive frequency.
 2. Press the [FUNC] key.
 3. Select [OPERATION SETTING] → [GENERAL] → [QUICK SPLIT INPUT].
 4. Select "ON".
 5. Press the [FUNC] key to save the new setting and exit the Setting Menu.
 6. Press the [FUNC] key to exit to normal operation.
 7. Press and hold the [SPLIT] key.
 8. Enter the offset frequency with the keyboard on the screen, then touch [kHz].
- The frequency range that can be input is from -20 kHz to +20 kHz.

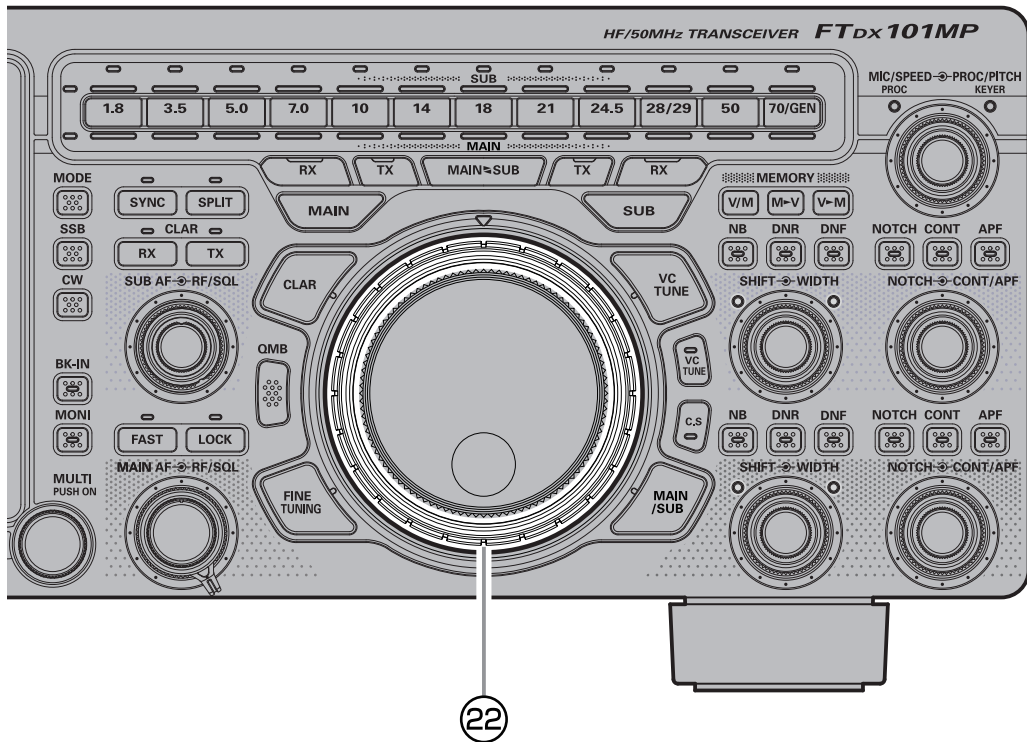

22 MPVD ring (MULTI PURPOSE VFO OUTER DIAL)

Select the MPVD operation by touching one of the keys: MAIN/SUB dial, VC TUNE, CLAR (Clarifier), C.S (Custom Select).

Change the function of the MPVD ring

The function of the MPVD ring can be changed simply by pressing the key below.

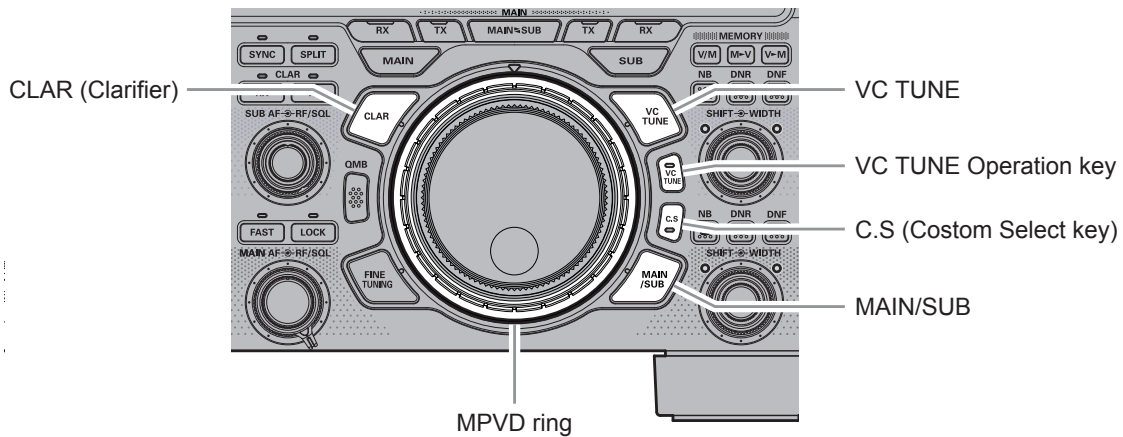

- CLAR: Acts as a clarifier knob.
- VC TUNE: Adjusts the tuning point when the VC tune function is activated.
- C.S: 11 types of functions can be assigned in advance.
- MAIN / SUB: Operates as a dial to set the frequency of the SUB band when the operation band is the MAIN band, and as the frequency of the MAIN band when the operation band is the SUB band.

Clarifier

The clarifier is used to adjust the receiver frequency of this transceiver to match the other station transmit frequency and improve the audio; or to shift the transmit frequency of this station when the transmit frequency of the contact station is shifted.

When the [CLAR] key is pressed, the MPVD multi-function ring becomes the Clarifier Dial and “CLAR” is displayed in gray below the filter function display on the TFT display.

Turning the MPVD ring changes the clarifier offset frequency.

When the [CLAR RX] or the [CLAR TX] key is pressed, the display changes from gray to red and the Clarifier operates.

To turn the clarifier OFF, press the [CLAR RX] or the [CLAR TX] key again.

• RX Clarifier

If the transmit frequency of the contact station is deviated, this receiver frequency can be changed leaving this transmit frequency unchanged.

1. Press the [CLAR] key on the top left of the MPVD ring to light the indicator.
2. Press the [CLAR RX] key.
3. Rotate the MPVD ring to change only the receive frequency.

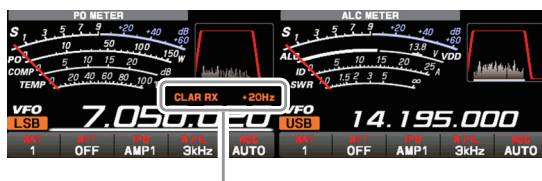

When the receive frequency is offset by +20 Hz.



- The “CLAR RX” will appear in the display, and the programmed offset will be applied to the receive frequency.
- Offsets of up to ± 9990 Hz may be set using the Clarifier.

4. To cancel Clarifier operation, press the [CLAR RX] key.

- Since the offset amount is memorized, when the clarifier function is operated again, the same offset amount is set.

To clear out the programmed clarifier offset altogether, and reset it to “zero,” press and hold the [CLAR RX], [CLAR TX] or [CLAR] key.

• Adjust transmit frequency to the offset frequency

After changing the receiver frequency with RX Clarifier, the transmitter frequency can be set to the same frequency as the receiver.

1. After offsetting the receiver frequency, press the [CLAR TX] key.
The transmit frequency becomes the same as the receive frequency.
 - “CLAR RX” of the display changes to “CLAR TRX”.
2. Press the [CLAR TX] key again, only the reception frequency returns to the offset state.
 - “CLAR TRX” of the display changes to “CLAR RX”.

• TX Clarifier

The transmit frequency can be changed without moving the receive frequency of the transceiver. Normally, the clarifier is used to move only the receive frequency and compensate for the deviation of the transmission frequency of the contact station, however alternatively, only the transmit frequency can be moved without changing the transmitter. When responding to an operator that is called by a large number of stations such as in a contest, etc., the response rate may increase if the transmit frequency is moved slightly.

1. Press the [CLAR] key on the top left of the MPVD ring to light the indicator.
2. Press the [CLAR TX] key.
3. Rotate the MPVD ring to change only the transmit frequency.



- The “CLAR TX” will appear in the display, and the programmed offset will be applied to the transmit frequency.
- Offsets of up to ± 9990 Hz may be set using the Clarifier.

4. To cancel Clarifier operation, press the [CLAR TX] key.

To clear out the programmed clarifier offset altogether, and reset it to “zero,” press and hold the [CLAR RX], [CLAR TX] or [CLAR] key.

• To offset the frequency with the TX Clarifier Adjust receive frequency

When the transmit frequency is offset with the TX Clarifier, it can be reset to the same frequency as the TX frequency offset from the receive frequency. After offsetting the transmit frequency, press the [CLAR RX] key.

The “CLAR TX” display changes to “CLAR TRX” and the receive frequency becomes the same as the transmit frequency.

VC TUNE

The VC tuning circuit drives the variable capacitor in the receiver RF front end with a high precision stepping motor, and effectively attenuates the strong intruding signals that are particularly problematic in the low band. If there are multiple disturbing signals, turning the MPVD ring allows fine tuning of the VC tuning point.

1. Press the [VC TUNE] operation key.
 - When the VC Tune is active, the LED lights red and a bar graph representing the position of the VC Tuning frequency is displayed in the filter function display.
 - The VC tune circuit will automatically align itself to the operating frequency.
2. To exit from VC tune operation, press the [VC TUNE] operation key.



When VC Tune operates, the display on the Scope Screen also changes significantly because the RF sensitivity changes greatly. Adjust the reference level with the [MULTI] knob or turn the MPVD ring to make fine adjustments.

• Fine tune the tuning point

1. Press the [VC TUNE] key (located at the upper right of the MAIN dial).
 2. Rotate the MPVD ring to peak the response (background noise) or reduce interference.
- Press and hold the [VC TUNE] operation key to re-center the filter response on the current operating frequency.



When VC Tune operates, the steep attenuation characteristics of VC Tuner may cause some signals in the Spectrum Scope to be attenuated and disappear, or the image may not appear uniform, however this is not a malfunction.



The VC-Tuning module in the FTDX101D is only for the MAIN band. If you also want to use it on the SUB band of the FTDX101D, please contact Yaesu.



The VC tune function works only with amateur bands from 1.8 MHz band to 29 MHz (except the 5 MHz band).

C.S (Custom Select)

By simply pressing the [C.S] key, the MPVD ring operates in the function that has been assigned to the [C.S] key (see below) (default setting is MEM CH).

RF POWER	Adjusts transmission output.
MONI LEVEL	Adjusts the Monitor level.
DNR LEVEL	DNR level adjustment.
NB LEVEL	NB level adjustment.
VOX GAIN	VOX gain adjustment.
VOX DELAY	VOX delay adjustment.
ANTI VOX	ANTI VOX adjustment.
STEP DIAL	Frequency change at a predetermined frequency step.
MEM CH	Selects the Desired memory channel.
GROUP	Selects the memory group.
R.FIL	Pass band width selection of Roofing filter.

• How to assign functions

1. Press and hold the [C.S] key.
The function selection screen is displayed.

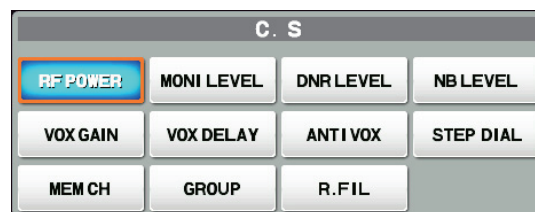

2. Touch the function you want to assign.

MAIN/SUB

When the MAIN/SUB key is pressed, the MPVD ring tunes the SUB band frequency. When operation is on the MAIN band. When operation is on SUB band. the ring tunes the frequency of the MAIN band.

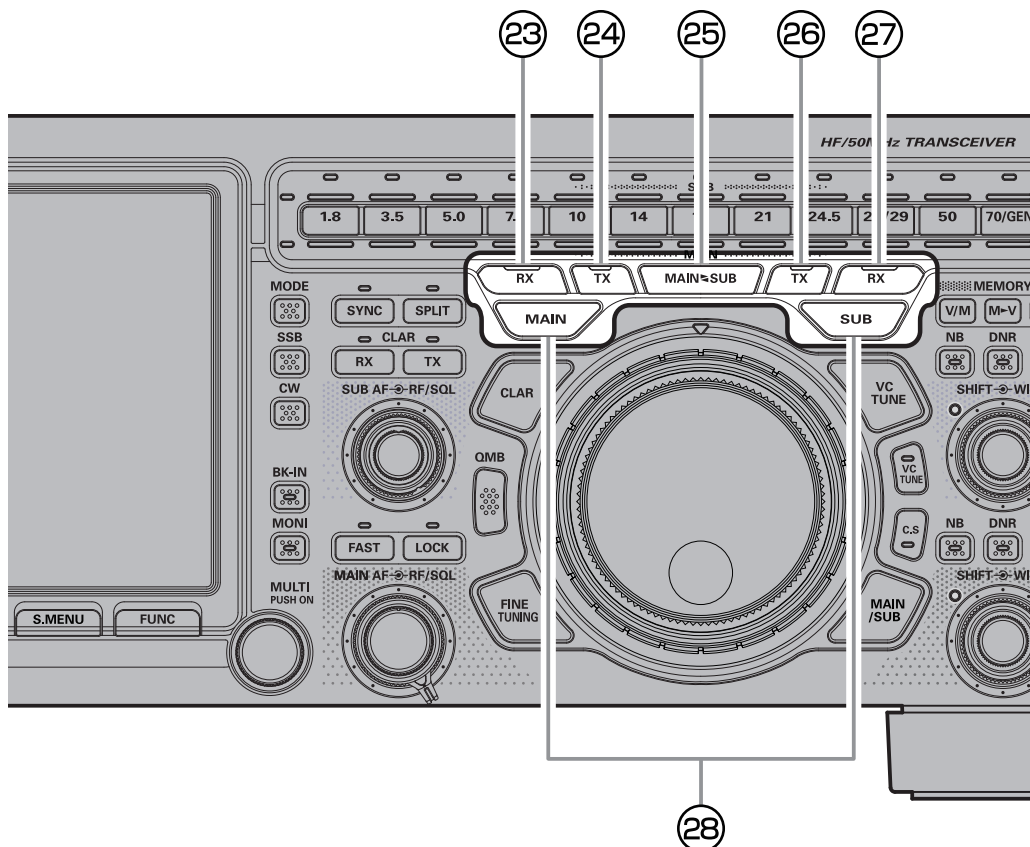

23 RX (MAIN band)

Press this key to activate receive on the MAIN band frequency. The LED inside the key will glow green when the transceiver is receiving on the MAIN band frequency.

When pressed, the MAIN band received audio is muted and the indicator is turned OFF.



- When muted, the bandwidth color changes from red to gray.
- The receiver audio will disappear but the band information will be displayed.

24 TX (MAIN band)

When this key is pushed, the LED inside the key will glow red; and, when the PTT switch is pressed, the transceiver will transmit on the MAIN band frequency.



To transmit at the SUB band frequency, press the SUB band side [TX] key.

25 MAIN \rightleftharpoons SUB

Pressing this key momentarily, exchanges the MAIN band and SUB band frequency data. If pressed and hold, both the MAIN and SUB bands will be the operating band frequencies.

26 TX (SUB band)

When this key is pushed, the LED inside the key will glow red; and, when the PTT switch is pressed, the transceiver will transmit on the SUB band frequency.



To transmit at the MAIN band frequency, press the MAIN band side [TX] key.

27 RX (SUB band)

Press this key to activate receive on the SUB band frequency. The LED inside the key will glow green when the transceiver is receiving on the SUB band frequency.

When pressed, the SUB band received audio is MUTED and the indicator is turned OFF.



- When muted, the bandwidth color changes from red to gray.
- The receiver audio will disappear but the band information will be displayed.

28 Switching bands to operate Dial knobs etc.

The MAIN band receiver (left side of the screen) and the SUB band receiver (right side of the screen) are completely independent dual receivers, with separate circuit configurations, different frequencies and operations.

Press the [MAIN] or [SUB] key to switch the receivers.

When the [MAIN] key appears in white, common dials and other knobs operate for the MAIN band. When the [SUB] key is shown in blue, common controls such as the dial controls operate for the SUB band.



The large frequency display with the underline is the current operating frequency.

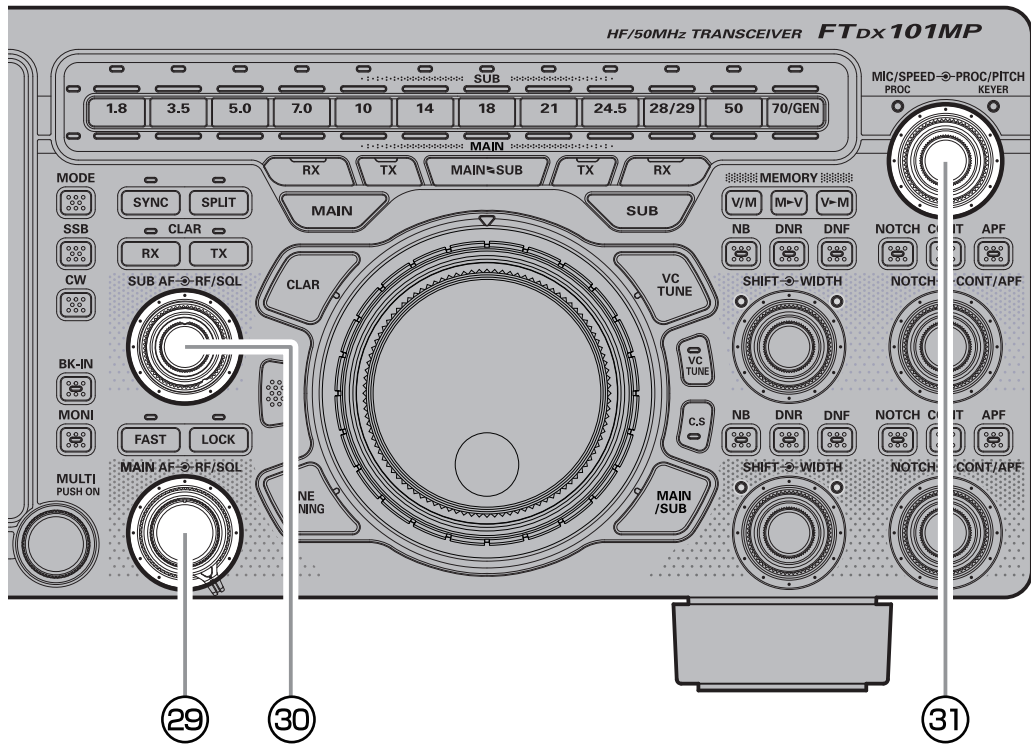

29 MAIN AF, RF/SQL

Inner Knob (MAIN AF)

The inner [MAIN AF] knob sets the audio level of the MAIN band receiver.

Outer Knob (RF/SQL)

RF

The RF Gain control provides manual adjustment of the gain levels for the receiver RF and IF stages, to account for noise and signal strength conditions at the moment.

[RF/SQL] knob is normally left in the fully clockwise position.

The RF Gain function can be adjusted individually for MAIN band and SUB band.



- Before operation, set the operation of the [RF/SQL] control to “RF” (see below). The default setting is “RF”.
- It does not operate in FM and DATA-FM mode.

SQL

The squelch system allows the back-ground noise to be muted when no signal is being received.

Normally, the squelch is not used during SSB or CW operation.



- Before operation, set the operation of the [RF/SQL] control to “SQL”. The default setting is “RF”.

Rotate the [RF/SQL] knob to adjust the squelch until the noise disappears.



- If the squelch knob is turned too far to the right, weak signals cannot be heard

• Switching the operation of the [RF/SQL] knob

1. Press the [FUNC] key.
2. Select [OPERATION SETTING]→[GENERAL] → [RF/SQL VR].
3. Select “RF” or “SQL”.
4. Press the [FUNC] key to save the new setting and exit the Setting Menu.
5. Press the [FUNC] key to exit to normal operation.



RF/SQL settings cannot be set separately for the MAIN band and the SUB band.

③⑩ SUB AF, RF/SQL

Inner Knob (SUB AF)

The inner [SUB AF] knob sets the audio level of the SUB band receiver.

It is similar to the MAIN Band knob operation.

Outer Knob (RF/SQL)

Adjusts the RF gain and the SQL (squelch).

It is similar to the MAIN Band knob operation.

③⑪ MIC/SPEED, PROC/PITCH

Inner Knob (MIC/SPEED)

Adjusts the microphone gain (microphone sensitivity) (0 to 100) in SSB and AM modes.

In CW mode, adjusts the keying speed of the built-in electronic keyer (4 WPM - 60 WPM).



When the knob is turned, the display will show the relative microphone gain or the keying speed for 1/2 second.

When pressed in SSB mode, turns the AMC or speech processor ON/OFF (page 50, 51).

When pressed in CW mode, the built-in electronic keyer is turned ON/OFF (page 60).

Outer Knob (PROC/PITCH)

In SSB mode, adjusts the level of AMC or the Speech Processor (1 to 100).

In CW mode, adjusts the CW tone (300 Hz to 1050 Hz) when receiving the CW signal and the side tone monitor.



When the outer [PROC/PITCH] knob is turned, the AMC level, Compression level or the Spot tone frequency setting will be shown for 1/2 second in the display.



Refer to "Voice Communications (SSB and AM)" on page 50 for the setting.

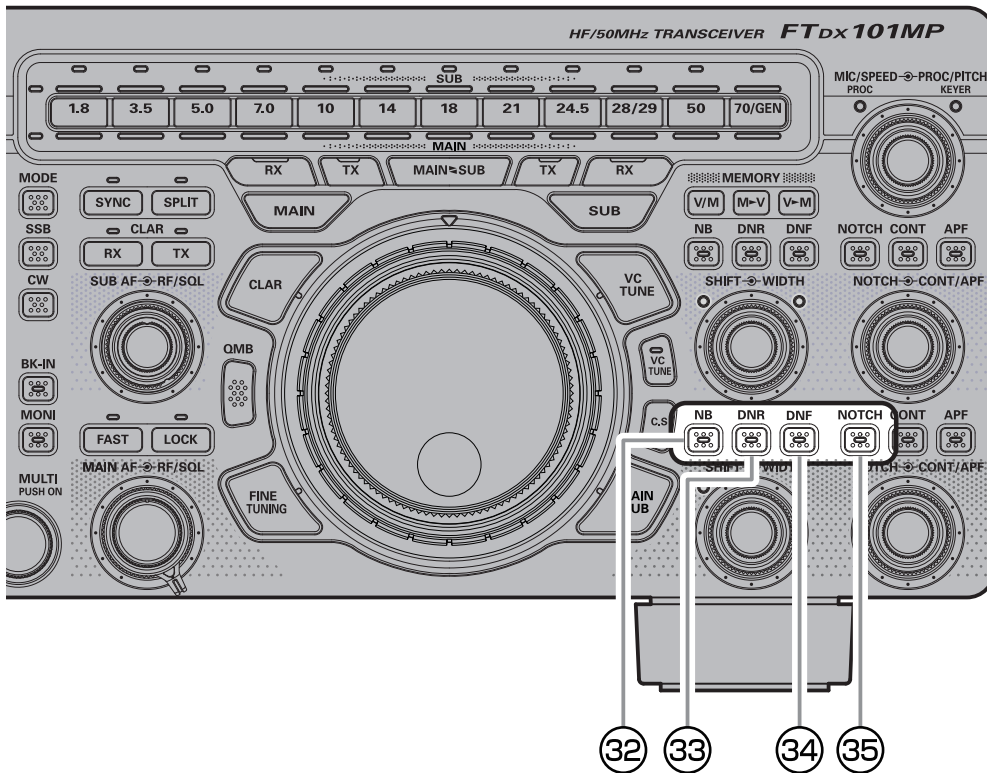

MAIN Band Operation

32 NB

The FTDX101 includes an effective IF Noise Blanking, which can significantly reduce noise caused by automotive ignition systems. The NB function can be operated individually for MAIN band and SUB band.

1. Press the [NB] key.
2. Press and hold the [NB] key and adjust the NB level with the [MULTI] knob.

To disable Noise Blanking operation, press the [NB] key once more.



The NB function may be less effective on some other types of interference.

• Adjusting the Noise Attenuation

1. Press the [FUNC] key.
2. Select [OPERATION SETTING]→[GENERAL]→[NB REJECTION].
3. Rotate the [MULTI] knob to set the noise attenuation (10dB / 30dB / 40dB).
4. Press the [FUNC] key to save the new setting and exit the Setting Menu.
5. Press the [FUNC] key to exit to normal operation.

• Reduces longer duration pulse noise

Reduces long duration noise as well as pulse noise.

1. Press the [FUNC] key.
2. Select [OPERATION SETTING]→[GENERAL]→[NB WIDTH].
3. Rotate the [MULTI] knob to select the value that will reduce the noise.
4. Press the [FUNC] key to save the new setting and exit the Setting Menu.
5. Press the [FUNC] key to exit to normal operation.

• Set the MULTI knob to NB level adjustment knob

1. Press the [FUNC] key.
2. Touch [NB LEVEL].
The [MULTI] knob will operate as the NB level adjustment knob.

33 DNR (Digital Noise Reduction)

The Digital Noise Reduction (DNR) system is designed to reduce the level of ambient noise found on the HF and 50 MHz bands. The (DNR) system is especially effective during SSB operation. Any of 15 different noise-reduction algorithms can be selected; each of these algorithms was created to deal with a different noise profile. You will want to experiment with the DNR system to find the best setting corresponding to the noise currently being experienced.

The DNR function can be operated individually for MAIN band and SUB band.

1. Press the [DNR] key.
2. Press and hold the [DNR] key, then rotate the [MULTI] knob to choose one of 15 algorithms that best reduces the noise level.

To disable the DNR system, press the [DNR] key once more.

34 DNF (Digital NOTCH Filter)

The Digital NOTCH Filter (DNF) is an effective beat-canceling filter that can null out a number of interfering beat notes inside the receiver passband. Because this is an Auto-Notch feature, there is no adjustment knob associated with this filter.

The DNF function can be operated individually for MAIN band and SUB band.

Press the [DNF] key, activate the DNF function. To disable the DNF system, press the [DNF] key once more.



If a very strong interfering carrier is encountered, we recommend using the IF NOTCH filter first, as it is the most effective notching tool in the receiver section.

35 NOTCH (IF NOTCH Filter)

The IF NOTCH filter is a highly effective system that allows you to slice out an interfering beat note or other carrier signal from inside the receiver passband.

The NOTCH function can be operated individually for MAIN band and SUB band.

1. Press the [NOTCH] key.
2. Rotate the [NOTCH] knob to adjust the “null” position of the Notch filter.

- The display will show the center frequency of the Notch for 1/2 second whenever the [NOTCH] knob is turned.
- Press and hold the [NOTCH] knob to return the center frequency to its initial value and disable the NOTCH filter function.
- On the filter function display area, you can check the position of the attenuation.

To cancel the NOTCH filter, press the [NOTCH] key momentarily.



The bandwidth of the NOTCH filter (either narrow or wide) may be adjusted using Menu item “IF NOTCH WIDTH” page 99. The factory default setting is “WIDE”.

The performance of the IF Notch filter is shown in Figure “A”, where the effect of rotation of the [NOTCH] knob is depicted. In Figure “B” you can see the notching effect of the IF Notch filter as you rotate the [NOTCH] knob to eliminate the incoming interference.

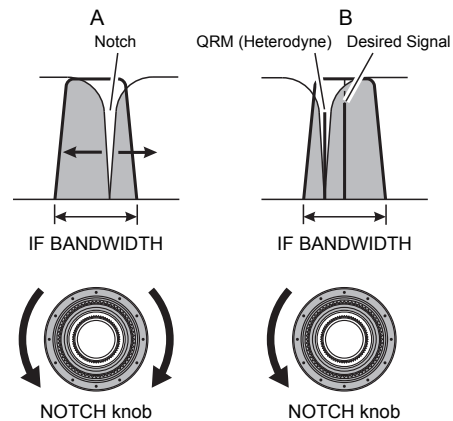

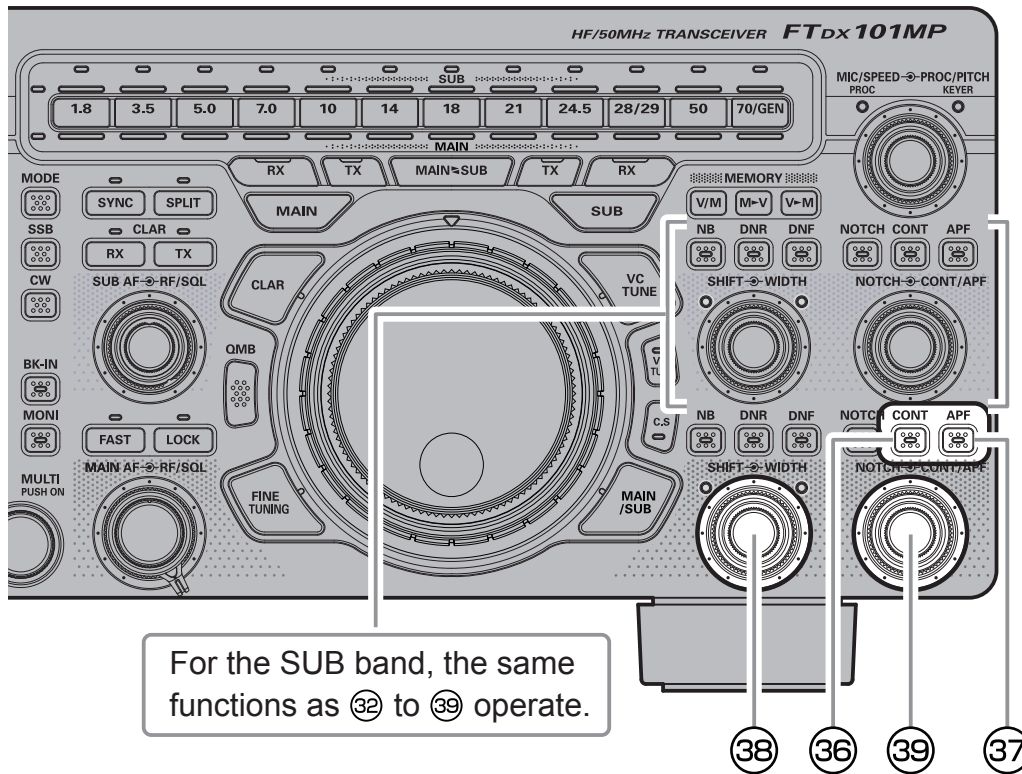

36 CONT (Contour)

The Contour filter system provides a gentle perturbation of the IF filter passband. The Contour is set to either suppress, or boost specific frequency components, and thus enhances the sound and readability of a received signal.

1. Rotate the [CONT/APF] knob to achieve the most natural-sounding audio reproduction of the incoming signal.
 - Rotate the [CONT/APF] knob, the center frequency (50 Hz - 3200 Hz) of the Contour is displayed.
 - Press and hold the [NOTCH] knob to return the center frequency to its initial value and disable the Contour function.
 - In the Filter Function Display, the attenuation in the passband can be observed.
2. To exit from Contour tuning, press the [CONT/APF] key momentarily.

Adjust the GAIN of the CONTOUR Circuit

1. Press the [FUNC] key.
2. Select [OPERATION SETTING] → [RX DSP] → [CONTOUR LEVEL].
3. Rotate the [MULTI] knob to set the CONTOUR circuit gain.
4. Press the [FUNC] key to save the new setting and exit the Setting Menu.
5. Press the [FUNC] key to exit to normal operation.

Sets the Bandwidth (“Q”) of the CONTOUR Circuit

1. Press the [FUNC] key.
2. Select [OPERATION SETTING] → [RX DSP] → [CONTOUR WIDTH].
3. Rotate the [MULTI] knob to set bandwidth (“Q”) of the CONTOUR circuit.
4. Press the [FUNC] key to save the new setting and exit the Setting Menu.
5. Press the [FUNC] key to exit to normal operation.

Refer to Figure “B”, this illustrates an “indentation” of the Contour filter in the center of the passband. Counterclockwise rotation (to the left) of the [CONT/APF] knob causes the notch to move toward a lower frequency within the passband (fig. A), while clockwise rotation (to the right) causes the notch to move toward a higher frequency within the passband (fig. C). By removing interference or unwanted frequency components of the incoming signal, it is possible to make the desired signal rise out of the background noise/interference, and enhance intelligibility.

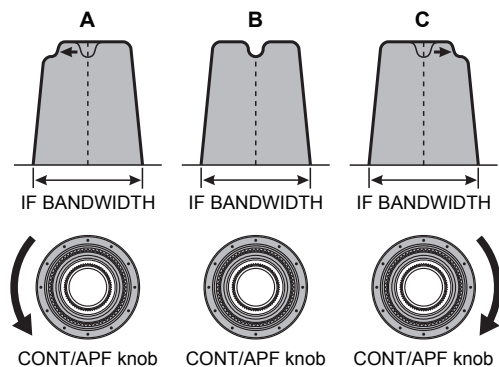

37 APF (Audio Peak Filter)

During CW operation, when interference or noise is present, the center frequency is automatically set to the PITCH frequency, making it easier to hear the desired signal.

The APF function can be operated individually for MAIN band and SUB band.

1. Rotate the [CONT/APF] knob to the left or right to reduce any interference.
- Rotate the [CONT/APF] knob to display the center frequency (-250Hz - +250Hz) of the audio peak filter.
- Press and hold the [NOTCH] knob to restore the APF peak center frequency setting to "0 Hz", and disable the APF function.
- The display will show the peak position of the APF, while tuning the SHIFT knob.



The APF bandwidth can be selected from NARROW / MEDIUM / WIDE via the Menu item "APF WIDTH" (page 99).

2. To exit from APF operation, press the [APF] key again.

38 SHIFT, WIDTH

Inner Knob (SHIFT)

IF SHIFT permits moving the DSP filter passband higher or lower, without changing the pitch of the incoming signal, and thus reduces or eliminates interference. Because the tuned carrier frequency is not varied, there is no need to re-tune the operating frequency to eliminate the interference.

The total passband tuning range for the IF SHIFT system is ± 1.2 kHz.

The SHIFT function can be operated individually for MAIN band and SUB band.

Rotate the [SHIFT] knob to the left or right to reduce interfering signals.

- Rotate the [SHIFT] knob to display the shift offset of the IF filter (-1200Hz to +1200Hz).
- Press and hold the [SHIFT] knob to quickly move the filter passband to center.
- On the filter function display area, you can observe the direction of the shift.
- While the SHIFT function is active, the indicator on the left side of the [SHIFT] knob will light.

Refer to Figure "A" and notice the depiction of the IF DSP filter as a thick line in the center of the passband.

In Figure "B", an interfering signal has appeared inside the original passband. In Figure "C", you can see the effect of rotating the [SHIFT] knob. The interference level is reduced by moving the filter passband so that the interference is outside of the passband.

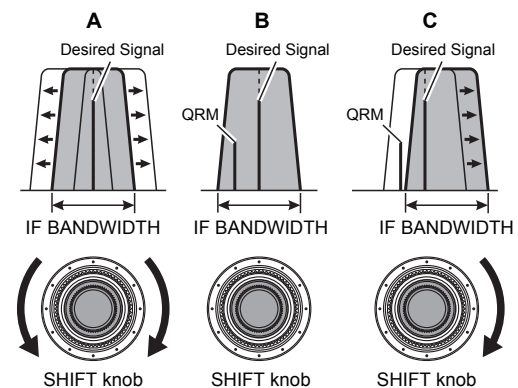

Outer Knob (WIDTH)

The IF WIDTH tuning system allows you to vary the width of the DSP IF passband, to reduce or eliminate interference.

Moreover, the bandwidth may actually be expanded from its default setting, should you wish to enhance incoming signal fidelity when interference on the band is low.

Rotate the [WIDTH] knob counter-clockwise to narrow the bandwidth and reduce interference.

- To increase the bandwidth, rotate the knob clockwise.
- Rotate the [WIDTH] knob, the IF filter bandwidth is displayed on the display.
- Press and hold the [SHIFT] knob to return the bandwidth of the IF filter to its initial value (see below).
- On the filter function display area, you can check the status of the bandwidth.
- While the WIDTH function is active, the indicator on the right side of the [WIDTH] knob will light.



WIDTH and SHIFT can be adjusted alternately, while listening for the best reception point. CONTOUR and NOTCH may be used together to effectively eliminate interference and increase intelligibility

Referring to Figure "B", you can see the default bandwidth of the SSB mode.

By rotating the [SHIFT] knob to the left, the bandwidth will narrow (see Figure "A"), while rotation of the [SHIFT] knob to the right, will increase the bandwidth as depicted in Figure "C".

The default bandwidths, and total bandwidth adjustment range, will vary according to the operating mode (see table below).

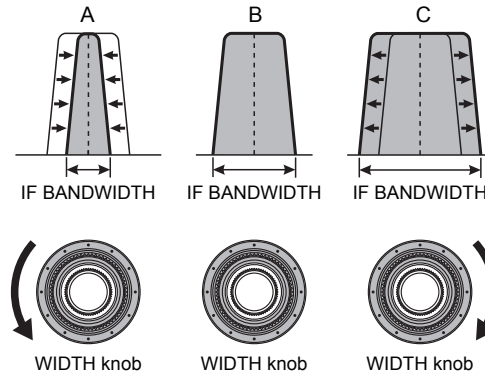

Operating Mode	IF BANDWIDTH
SSB (LSB/USB)	300 Hz - 4000 Hz (default: 3000 Hz)
CW (CW-L/CW-U), RTTY, PSK DATA (LSB/USB)	50 Hz - 3000 Hz (default: 500 Hz)
AM, FM-N, D-FM-N	9000 Hz
AM-N	6000 Hz
FM, DATA-FM	16000 Hz

Using IF SHIFT and WIDTH Together

The IF SHIFT and Variable IF WIDTH features together form a very effective interference-fighting filtering system.

For example, in Figure "A", you can see how interference has appeared both on the high and low sides of the desired signal.

Rotate the [WIDTH] knob, the interference from one side can be eliminated (Figure "B"). Next, rotate the [SHIFT] knob to re-position the passband (Figure "C"), the interference on the opposite side can be removed, without re-introducing the interference previously eliminated in Figure "B".

For best interference reduction, the WIDTH and SHIFT features are the primary tools you should use, after narrowing the bandwidth (WIDTH) and/or adjusting the center of the passband (SHIFT). The Contour control may then yield additional signal-enhancement benefits on the net residual bandwidth. Even more, the IF NOTCH Filter (described later) may also be used, in conjunction with these filter systems, to significant advantage.

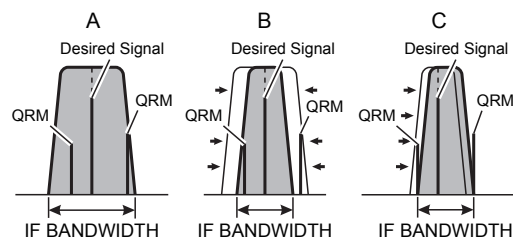

39 NOTCH, CONT/APF

Inner Knob (NOTCH)

Rotate the inner [NOTCH] knob to adjust the center frequency of the IF NOTCH filter. Press the [NOTCH] key to turn the IF NOTCH filter ON or OFF.

The null position of the IF NOTCH filter can be observed on the display.

Additionally, the display will show the center frequency of the IF NOTCH filter for 0.5 second whenever the [NOTCH] knob is turned.

Press and hold to reset NOTCH, CONTOUR, APF.

Outer Knob (CONT/APF)

The DSP CONTOUR operation can alter the profile of the passband to partially attenuate an in-band frequency component.

The CONTOUR operation can be switched ON/OFF with the [CONT] Key.

The influence of CONTOUR is depicted graphically on the display.

If there is interference or noise during CW operation, the APF center frequency is automatically set to the CW PITCH frequency as a "peak filter", to make it easier to hear the desired signal.

APF operation is switched ON / OFF with the [APF] key.

The location of the APF peak frequency is graphically illustrated on the display.



When the knob is turned, the center frequency of NOTCH, the center frequency of CONTOUR, or the Peak Frequency shift width of the of the APF will be illustrated on the display for 0.5 seconds.

Voice Communications (SSB and AM)

When transmitting in SSB or AM mode

The FTDX101 series transmit audio circuit can be set to the optimum operating level by individually adjusting the input and output gains of the microphone amplifier.



The AMC (Automatic Microphone Gain Control) regulates the microphone audio so that distortion does not occur, even if excessive audio is input.

1. Adjust Microphone gain

Touch the Meter Display on the right and then touch "ALC" to select the ACL Meter.

Key TX and adjust the [MIC/SPEED] knob to set the input level of the Microphone Amplifier to the position where the ALC Meter needle does not exceed the ALC zone on the audio peaks.

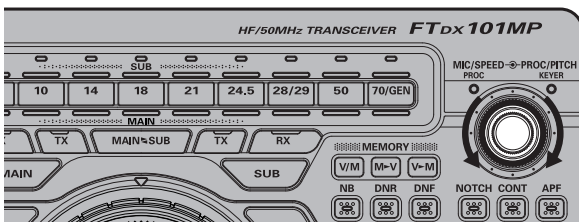

2. Adjust the AMC gain

If the indicator on the left side of the [MIC/SPEED] control is ON, press the [MIC/SPEED] knob so that the indicator is OFF.

Touch the left side of the Meter Display, and then touch "COMP" to select the COMP meter.

Activate the transmit and speak into the microphone while adjusting the AMC level with the [PROC/PITCH] knob.

- Adjust the AMC to a point where the COMP Meter deflection does not exceed "10 dB" on the audio peaks.

Setup is completed.



Touch the [MONI] key listen to the quality of your transmitted signal (page 36).



The AMC function only works in SSB, AM, DATA-L and DATA-U modes. It does not work in other modes.

AMC/Compression level adjustment setting

The AMC function that automatically adjusts the audio level so that distortion does not occur even with excessive audio input, works in all modes. The [PROC/PITCH] knob acts as a level control knob for the AMC function.

1. Press the [FUNC] key.
2. Select [OPERATION SETTING] → [TX AUDIO] → [PROC LEVEL].
3. Select the operation for which the [PROC/PITCH] control will adjust the level.

COMP: Press the [MIC/SPEED] knob to turn the speech processor function ON and then adjust the compression level with the [PROC/PITCH] knob. When the speech processor function is turned OFF, the level of the AMC function may be adjusted with the [PROC/PITCH] knob.

AMC: The [PROC/PITCH] knob acts as the level control knob for the AMC function, regardless of whether the speech processor function is ON or OFF.

4. Press the [FUNC] key to save the new setting and exit the Setting Menu.
5. Press the [FUNC] key to exit to normal operation.

Speech Processor

The FTDX101 Speech Processor is designed to increase “talk power” by increasing the average power output of the transmitted SSB signal.



The speech processor function only works in SSB mode.
It does not work in other modes.

1. Press the [FUNC] key.
2. Select [OPERATION SETTING] → [TX AUDIO] → [PROC LEVEL].
3. Select [COMP].
4. Press the [FUNC] key to save the new setting and exit the Setting Menu.
5. Press the [FUNC] key to exit to normal operation.
6. Adjust the MIC gain, as described in Parametric Microphone Equalizer on Parametric Microphone Equalizer (page 52).
7. Touch the left meter area on the display to select the “COMP” meter.
The transmit meter becomes the “COMP” meter.
8. Press the [MIC/SPEED] knob.
While the Speech Processor function is active, the indicator on the left side of the [MIC/SPEED] knob will light.
9. Press the PTT switch on the microphone, and speak into the microphone in a normal voice level.
10. Adjust the [PROC/PITCH] knob to set the compression level within 10 dB.

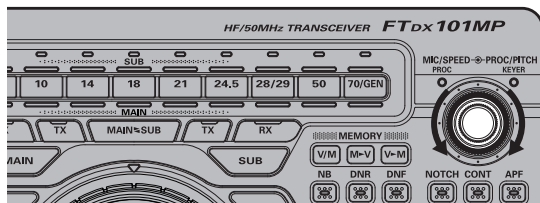

- The Transmit Monitor is a helpful aid to verify proper adjustment of the Compression level.

To switch the Speech Processor OFF, press the [MIC/SPEED] knob once more.



The speech processor can distort the transmit waveform when used to increase the average TX power, so it is not used in normal communication.

RF Power output control

Turn the [MULTI] knob to adjust the RF power output.

1. Press the [FUNC] key.
2. Touch [RF POWER].
3. Rotate the [MULTI] knob to adjust the RF power.

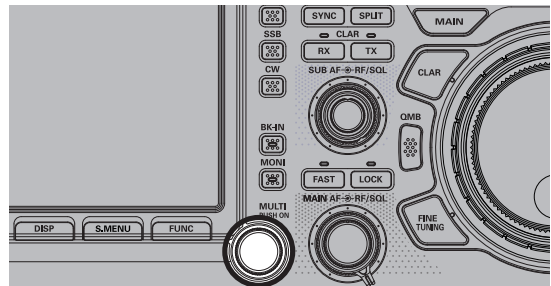

When transmitting in the AM mode, set a maximum (carrier) power output of 50 Watts (for FTDX101MP) or 25 Watts (for FTDX101D).

• Setting of maximum transmission output

The maximum transmit power can be set for each of the HF Bands, the 50 MHz band and the AM mode.

Set according to the operation situation, when you do not need large transmission output.

1. Press the [FUNC] key.
2. Select [OPERATION SETTING] → [TX GENERAL].
3. Rotate the [MULTI] Knob to select the item you want to set.

HF MAX POWER (HF band)

(The setting range is 5 to 200 W^{*1})

50M MAX POWER (50 MHz band)

(The setting range is 5 to 200 W^{*1})

70M MAX POWER (70 MHz band)

(The setting range is 5 to 50 W)

AM MAX POWER (AM mode)

(The setting range is 5 to 50 W^{*2})

^{*1}FTDX101D is 100 W

^{*2}FTDX101D is 25 W

4. Press the [FUNC] key to save the settings and return to the function screen.
5. Press the [FUNC] key to return to the normal operation screen.



Normally set to maximum output.

Parametric Microphone Equalizer

The FTDX101 includes a unique Three-Band Parametric Microphone Equalizer that provides precise, independent control over the low, mid and treble ranges in the voice waveform. One group of settings may be utilized when the AMC or speech processor is Off, and an alternate group of settings when the AMC or Speech Processor is On (SSB mode only). The speech processor feature is described in the next chapter.



Parametric microphone equalizer function is activated only in SSB, AM and FM modes.

• Setup the Parametric Microphone Equalizer

1. Set the RF output power to minimum value.



We recommend connecting a dummy load to one of the Antenna jacks, and monitoring the signal on a separate receiver, to prevent interference to other users.

2. Press the [FUNC] key.
3. Touch [MIC EQ] .
Parametric Microphone Equalizer function is activated.
 - To adjust the Parametric Microphone Equalizer with the AMC or speech processor engaged, press the [MIC/SPEED] knob to activated AMC or speech processor.
4. Press the [MONI] key, if you choose to listen on the FTDX101 internal monitor.
5. Press the [FUNC] key.
6. Select [OPERATION SETTING]→[TX AUDIO].
7. Rotate the [MULTI] knob to find Menu items [PRMTRC EQ1 FREQ] through [PRMTRC EQ3 BWTH]; these parameters apply to the adjustment of the Parametric Microphone Equalizer when the AMC or speech processor is disabled.
Menu items [P PRMTRC EQ1 FREQ] through [P PRMTRC EQ3 BWTH] apply to the adjustment of the Parametric Microphone Equalizer when the AMC or speech processor is engaged.
8. Press the [MULTI] knob, then rotate the [MULTI] knob to adjust a particular Menu item.
9. Press and hold the PTT switch, and speak into the microphone while listening to the effect of the adjustments being made. Because the overall sound will change with each adjustment, make several passes through each adjustment area, to be sure that the optimum settings are achieved.
 - The best way to hear the effects of the adjustments is to wear headphones (connected to the monitor receiver) while listening to the transmitted signal.
10. When all adjustments are satisfactory, press the [FUNC] key to save the new settings and exit the Setting Menu.
11. Press the [FUNC] key to exit to normal operation.

• Activate the Parametric Microphone Equalizer

1. Adjust the MIC gain, as described on page 50.
2. Press the [FUNC] key.
3. Touch [MIC EQ] .
Parametric Microphone Equalizer function is activated.
 - If the Parametric Microphone Equalizer is used with the AMC or speech processor engaged, press the [MIC/SPEED] knob.
4. Press the PTT switch on the microphone, and speak into the microphone in a normal voice level.

To cancel the Parametric Microphone Equalizer function, repeat steps 2 and 3 above, and choose "OFF" in step 3.

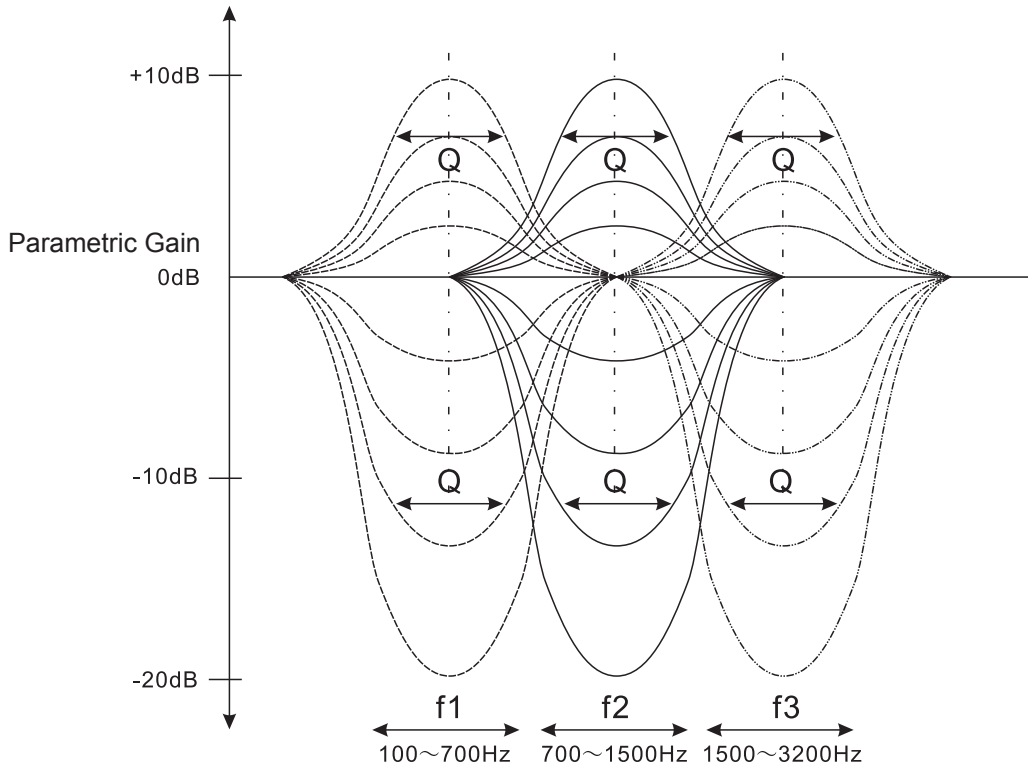

3-Stage Parametric Equalizer Adjustments (Speech Processor: "OFF")

Center Frequency	PRMTRC EQ1 FREQ	(Low) "100" (Hz) - "700" (Hz) / OFF	OFF
	PRMTRC EQ2 FREQ	(Mid) "700" (Hz) - "1500" (Hz) / OFF	
	PRMTRC EQ3 FREQ	(High) "1500" (Hz) - "3200" (Hz) / OFF	
Parametric Gain	PRMTRC EQ1 LEVEL	(Low) "-10" (dB) - "+10" (dB)	+5
	PRMTRC EQ2 LEVEL	(Mid) "-10" (dB) - "+10" (dB)	
	PRMTRC EQ3 LEVEL	(High) "-10" (dB) - "+10" (dB)	
Q (Bandwidth)	PRMTRC EQ1 BWTH	(Low) "0" - "10"	10
	PRMTRC EQ2 BWTH	(Mid) "0" - "10"	
	PRMTRC EQ3 BWTH	(High) "0" - "10"	

3-Stage Parametric Equalizer Adjustments (AMC or Speech Processor: "ON")

Center Frequency	P PRMTRC EQ1 FREQ	(Low) "100" (Hz) - "700" (Hz) / OFF	OFF
	P PRMTRC EQ2 FREQ	(Mid) "700" (Hz) - "1500" (Hz) / OFF	
	P PRMTRC EQ3 FREQ	(High) "1500" (Hz) - "3200" (Hz) / OFF	
Parametric Gain	P PRMTRC EQ1 LEVEL	(Low) "-10" (dB) - "+10" (dB)	0
	P PRMTRC EQ2 LEVEL	(Mid) "-10" (dB) - "+10" (dB)	
	P PRMTRC EQ3 LEVEL	(High) "-10" (dB) - "+10" (dB)	
Q (Bandwidth)	P PRMTRC EQ1 BWTH	(Low) "0" - "10"	2
	P PRMTRC EQ2 BWTH	(Mid) "0" - "10"	1
	P PRMTRC EQ3 BWTH	(High) "0" - "10"	

Center Frequency: The center frequency of each of the three bands may be adjusted.

Gain: The amount of enhancement (or suppression) within each band may be adjusted.

Q: The bandwidth over which the equalization is applied may be adjusted.

Voice Memory

The Voice Memory capability of the FTDX101 may be used to store and replay often repeated messages. The Voice Memory includes five memories, each capable of storing up to a maximum of 20 seconds of voice audio.

The Voice Memory may be operated from the Display Panel, or from the optional FH-2 Remote Control Keypad, which plugs into the rear panel REM jack.

• Recording Your Own Voice in Memory

1. Select the SSB or AM mode.
When using FH-2, go to step 4.
2. Press the [FUNC] key.
3. Touch [REC/PLAY].
4. Touch [MEM] on the display or press the [MEM] key on the FH-2.
A blinking "REC" will appear in the display.



If a [1] through [5] key (see next step) is not pressed within five seconds, the memory storage process will be cancelled.

5. Touch [1] through [5] on the display or press any of the FH-2 keys numbered [1] through [5] to select that memory storage register.
6. Press the microphone PTT switch momentarily. The "REC" icon will glow steadily and recording will begin.
 - Remember that the time limit for recording any message is 20 seconds.
7. Touch [MEM] on the display or press the FH-2 [MEM] key to complete the message storage process.

• Checking the Recording

1. Be sure that [BK-IN] function is "OFF" so transmit will not be activated (the LED imbedded in the [BK-IN] key must be Off).
When using FH-2, go to step 4.
2. Press the [FUNC] key.
3. Touch [REC/PLAY].
4. Touch [1] through [5] on the display or press the FH-2 [1] through [5] key (whichever register was just recorded in). The "MSG" icon will appear in the display and the audio recorded in the Voice Memory will be heard.
 - To adjust the playback volume level, touch, [RX LEVEL] and turn the [MULTI] knob.

• Transmitting the Recorded Message

1. Select the SSB, AM or FM mode.
Be sure the [BK-IN] functions is "ON" so transmit will be activated (the LED imbedded in the [BK-IN] key must be On).
When using FH-2, go to step 4.
2. Press the [FUNC] key.
3. Touch [REC/PLAY].
4. Touch [1] through [5] on the display or press the FH-2 [1] through [5] key (whichever memory was recorded in). A "MSG" icon will appear in the display and the message will be transmitted.
 - To adjust the output level during transmit, touch [TX LEVEL] and turn the [MULTI] knob.

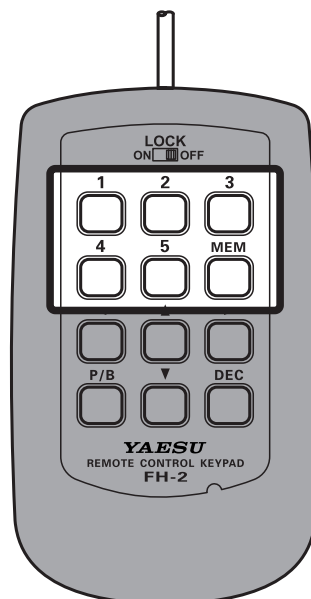

Adjustable Receiver Audio Filter

The FTDX101 incorporates an adjustable receiver audio filter, that affords precision control of the low; lower and upper audio ranges independently.

1. Press the [FUNC] key.
2. Select [RADIO SETTING].
3. Select the Mode and Menu Item you want to set (see table below).
4. Adjust the receiver audio response as desired.
5. Press the [FUNC] key to save the new setting and exit the Setting Menu.
6. Press the [FUNC] key to exit to normal operation.

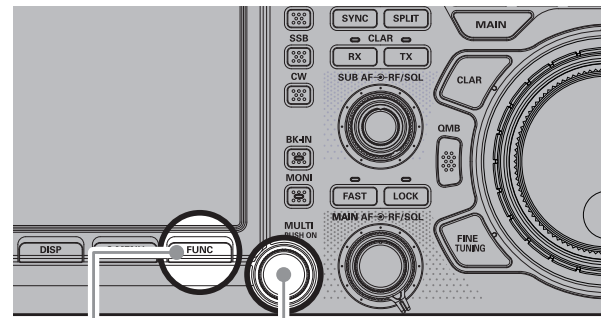

FUNC key

MULTI knob

Mode	Menu Item	Available Values	Default
MODE SSB	LCUT FREQ	OFF/100Hz - 1000Hz (50Hz step)	100Hz
	LCUT SLOPE	6dB/oct / 18dB/oct	6dB/oct
	HCUT FREQ	700Hz - 4000Hz (50Hz step)/OFF	3000Hz
	HCUT SLOPE	6dB/oct / 18dB/oct	6dB/oct
MODE AM	LCUT FREQ	OFF/100Hz - 1000Hz (50Hz step)	OFF
	LCUT SLOPE	6dB/oct / 18dB/oct	6dB/oct
	HCUT FREQ	700Hz - 4000Hz (50Hz step)/OFF	OFF
	HCUT SLOPE	6dB/oct / 18dB/oct	6dB/oct
MODE FM	LCUT FREQ	OFF/100Hz - 1000Hz (50Hz step)	300Hz
	LCUT SLOPE	6dB/oct / 18dB/oct	18dB/oct
	HCUT FREQ	700Hz - 4000Hz (50Hz step)/OFF	3000Hz
	HCUT SLOPE	6dB/oct / 18dB/oct	18dB/oct
MODE DATA	LCUT FREQ	OFF/100Hz - 1000Hz (50Hz step)	300Hz
	LCUT SLOPE	6dB/oct / 18dB/oct	18dB/oct
	HCUT FREQ	700Hz - 4000Hz (50Hz step)/OFF	3000Hz
	HCUT SLOPE	6dB/oct / 18dB/oct	18dB/oct
MODE RTTY	LCUT FREQ	OFF/100Hz - 1000Hz (50Hz step)	300Hz
	LCUT SLOPE	6dB/oct / 18dB/oct	18dB/oct
	HCUT FREQ	700Hz - 4000Hz (50Hz step)/OFF	3000Hz
	HCUT SLOPE	6dB/oct / 18dB/oct	18dB/oct

Using the Automatic Antenna Tuner

The Automatic Antenna Tuner (ATU) is built into each FTDX101 series. The ATU is designed to ensure that a 50-Ohm antenna impedance load is presented to the final amplifier stage of the transmitter.

- Because the FTDX101 ATU is located inside transceiver, it can only adjust the impedance presented to the transceiver end of the coaxial cable feedline. It does not “tune” the SWR at the antenna feed point itself. When designing and building an antenna system, we recommend that every effort be made to also ensure a low SWR at the antenna feed point.
- The ATU in the FT-2000D is designed to match impedances within the range of 16.5 Ohms to 150 Ohms, corresponding to an SWR of 3:1 or less on the HF amateur bands (6 m amateur band: 25 Ohms to 100 Ohms, corresponding to an SWR of 2:1 or less). Accordingly, simple non-resonant whip antennas, along with random-length wires and the “G5RV” antenna (on most bands) may not be within the impedance matching range of the ATU.
- The built-in antenna tuner cannot be used with an antenna connector connected to an external antenna tuner (page 102).



• ATU Operation

1. Press the [TUNE] key momentarily to place the ATU in the transmit line (no adjustment or tuning will occur yet).

While the ATU function is activated, the LED inside the [TUNE] key glows orange.

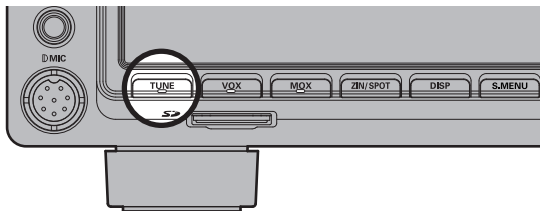

- The momentary press of the [TUNE] key will turn the tuner ON, and the microprocessor will automatically select the tuning point closest to the current operating frequency.
2. Press and hold the [TUNE] key to begin automatic tuning.
 - The transmitter will be engaged, and the LED inside [TUNE] key will blink while tuning is in progress.
 - Always listen on the operating frequency before beginning the tuning process, to be sure tuning will not interfere with others who may already be using the frequency.
 - When the optimum tuning point has been achieved, the transceiver will return to receive, and the LED inside the [TUNER] key will again glow steadily (instead of blinking).
 3. To disengage the ATU from the transmit line, press the [TUNE] key momentarily.



The ATU microprocessor memories store the record of the capacitors and inductors selected to tune each 10 kHz window in which tuning has occurred. This eliminates the need to re-tune every time operation returns to a frequency on which the tuning process has already been completed.

Figure 1 depicts a situation where normal tuning via the ATU has been successfully completed, and the tuning data has been stored in the ATU memory. The antenna system SWR as seen by the transmitter is shown.

In Figure 2, the operator has changed frequency, and the “HI-SWR” icon has appeared. The operator presses and holds in the TUNE button for one second to begin impedance matching using the ATU.

If a high SWR condition exists (above 3:1), corrective action must be taken in the antenna system to bring the impedance closer to 50 Ohms. The ATU will refuse to memorize settings on frequencies where the SWR exceeds 3:1. A High SWR may indicate a mechanical failure in the feed system, and can lead to the generation of spurious signals causing TVI, etc.

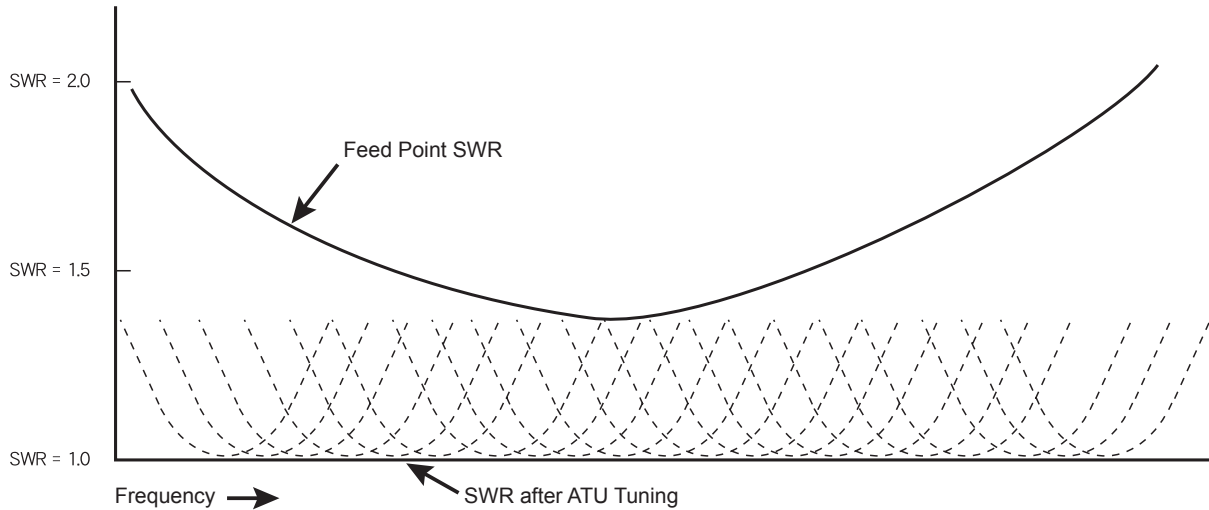

Figure 1

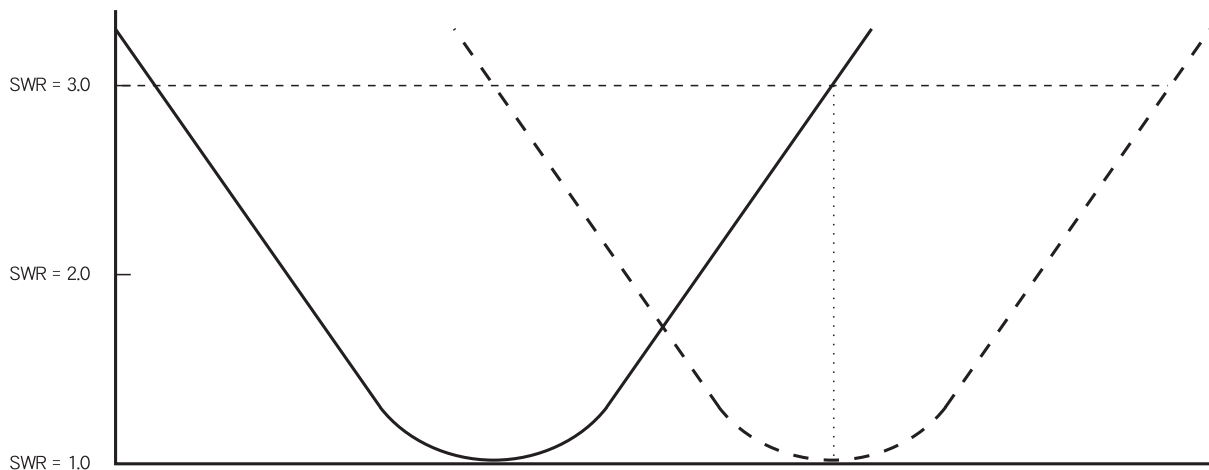

Figure 2

About ATU Memories

SWR (After tuning) Less than 2:1

The tuner settings are stored in the ATU memory.

SWR (After tuning) Greater than 2:1

Tuning data will not be retained in memory. If operation is returned to the same frequency, the tuning process must be repeated.

SWR (After tuning) Greater than 3:1

The “HI-SWR” icon will light up, and the tuner settings, if achieved, will not be memorized. Investigate the high SWR condition and resolve the problem before attempting further operation using this antenna.

CW Mode Operation

The impressive CW operating capabilities of the FTDX101 permit operating with an Electronic Keyer Paddle, a “Straight Key”, or a computer based keying device.

1. Before starting, connect the key cable(s) to the front and/or rear panel KEY jack(s).
2. Press the [CW] key to engage CW mode.

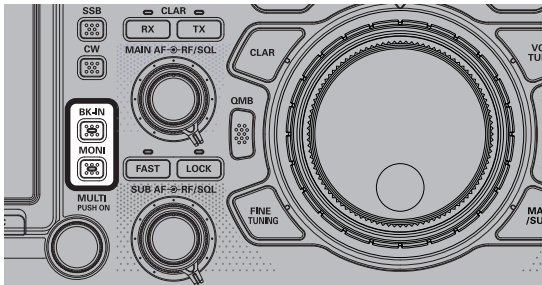

3. Rotate the Main Tuning Dial knob to select the desired operating frequency.
4. Press the [BK-IN] key to engage automatic activation of the transmitter when you close the CW key.
The LED inside the [BK-IN] key glows orange.
5. Press the [MONI] key.
The LED inside the [MONI] key glows orange; and the CW monitor is activated.
6. When using the keyer paddle, press the [MIC/SPEED] knob.
The indicator on the right side of the the [MIC/SPEED] knob glows orange; and the built-in Electronic Keyer is activated.
7. When the key or the keyer paddle is pressed, the transmitter will automatically be engaged.

- Rotate the [MIC/SPEED] knob to set the desired sending speed.
- As shipped from the factory, the FTDX101 CW TX/RX is configured for “Semibreak-in” operation. However, using Menu item “CW BK-IN TYPE” (page 93), this set-up may be changed to full break-in (QSK) operation, wherein the switching is quick enough to hear incoming signals in the spaces between the dots and dashes of the transmission. This may prove very useful during contest and traffic handling operations.
- If the [BK-IN] key is set to Off, CW sending may be practiced with the sidetone only, without having the signal transmitted over the air.
- To enable the CW keying operation in LSB/USB mode and send CW signals without switching the transceiver to CW mode, change Menu item “CW AUTO MODE” (page 93).

Note: “CW AUTO MODE” operation Select CW mode, Press the BK-IN button, and then select the SSB mode (LSB or USB).

- The same operating frequency may be maintained and displayed when switching the transceiver between SSB and CW mode, by setting Menu item “CW FREQ DISPLAY” (page 94).
- By connecting the FTDX101 to a computer, CW can be operated using free or commercially available software and setting Menu item “PC KEYING” (page 94).

• Adjusting the Sidetone Audio level

The CW sidetone audio level may be adjusted by pressing and holding the [MONI] key, and then rotating the [MULTI] knob.

• CW Delay Time Setting

During semi-break-in (not QSK) operation, the hang time of TX, after the transmitting ends may be adjusted to a comfortable value corresponding with the sending speed.

1. Press the [FUNC] key.
2. Select [CW SETTING]→[MODE CW]→[CW BK-IN DELAY].
3. Start sending and rotate the [MULTI] knob to adjust the hang time for comfortable operation.
4. Press the [FUNC] key to save the new setting and exit the Setting Menu.
5. Press the [FUNC] key to exit to normal operation.

CW Decode

Alphanumeric Morse code can be decoded and displayed as text on the TFT Panel.



Interfering signals, noise, propagation phasing, and code inaccuracy, may prevent accurate message copy.

1. Press the [CW] key to set the operating mode to CW.
2. Turn the [MIC/SPEED] knob to closely match the speed of the received CW signal. If the speed is significantly different, it may not be deciphered correctly.
3. Press the [FUNC] key.
4. Touch [DECODE].
The CW DECODE screen is displayed, and the decoded message text will appear on the screen.



- If extraneous characters are displayed, due to noise and clutter when a CW signal is not being received, touch [DEC LVL] and then rotate the [MULTI] knob to adjust the threshold level.
5. To cancel the CW decode function, touch [DEC OFF].

CW Spotting (Zero-Beating)

“Spotting” (zeroing in on another CW station) is a handy technique to ensure the transceiver and the other station are operating precisely on the same frequency.

The Tuning Offset Indicator in the display may also be moved to adjust the receiver frequency to center on the incoming station with the CW pitch corresponding to that of the transmit signal.

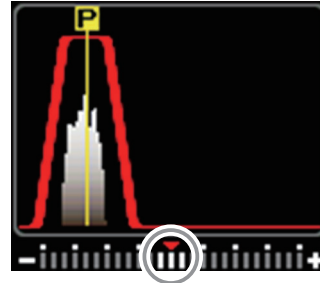

Zero-In



The turn OFF the Tuning Offset Indicator using Menu item “CW INDICATOR” page 94.

Setting of the Electronic Keyer

• Adjusting the Keyer Speed

Keyer speed can be adjusted by rotating the [MIC/SPEED] knob.

Rotate the [MIC/SPEED] knob to set the desired sending speed (4 wpm - 60 wpm).

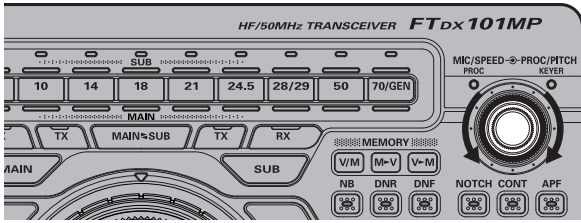

• Setting the Keyer Weight (Dot/Dash) Ratio

This Menu item may be used to adjust the dot/dash ratio for the built-in Electronic Keyer. The default weighting is 3:1 (a dash is three times longer than a dot).

1. Press the [FUNC] key.
2. Select [CW SETTING] → [KEYER] → [CW WEIGHT].
3. Rotate the [MULTI] knob to set the weight to the desired value. The available adjustment range is a Dot/Dash ratio of 2.5 - 4.5 (default value: 3.0).
4. Press the [FUNC] key to save the new setting and exit the Setting Menu.
5. Press the [FUNC] key to exit to normal operation.

• Reversing the Keyer Polarity

The Keyer polarity can be reversed easily in the Menu mode without changing the keyer connections (the default setting is "NOR"). Example: for left-handed operators in a contest.



In the Keyer modes described on the chart at the right, BUG and OFF modes are not changed.

1. Press the [FUNC] key.
2. Select [CW SETTING] → [KEYER].
3. Select [F KEYER DOT/DASH] or [R KEYER DOT/DASH].
4. Select "REV".
5. Press the [FUNC] key to save the new setting and exit the Setting Menu.
6. Press the [FUNC] key to exit to normal operation.

• Selecting the Keyer Operating Mode

The configuration of the Electronic Keyer may be customized independently for the front and rear KEY jacks of the FT DX101. This permits utilization of Automatic Character Spacing (ACS), if desired. This permits the use of an electronic keyer via the front jack and a straight key or computer-driven keying line via the rear panel jack.

1. Press the [FUNC] key.
2. Select [CW SETTING] → [KEYER].
3. Select [F KEYER TYPE] (for the front KEY jack) or [R KEYER TYPE] (for the rear-panel KEY jack).
4. To set the keyer to the desired operating mode, see the table below.
5. Press the [FUNC] key to save the new setting and exit the Setting Menu.
6. Press the [FUNC] key to exit to normal operation.

OFF	The built-in Electronic Keyer is turned off ("straight key" mode).
BUG	Dots will be generated automatically by the keyer, but dashes must be sent manually.
ELEKEY-A	A code element ("Dot" or "Dash" side) is transmitted upon releasing both sides of the paddle.
ELEKEY-B	Releasing both sides of the paddle transmits the currently generated "Dash" side followed by "Dot" side (or reverse order).
ELEKEY-Y	Pressing both sides of the paddle transmits the currently generated "Dash" side followed by "Dot" side (or reverse order). While transmitting the "Dash" side, the first transmitted "Dot" side will not be stored.
ACS	Same as "ELEKEY" except that the spacing between characters is precisely set by the keyer to be the same length as a dash (three dots in length). <div style="display: flex; align-items: center;"> <div style="margin-right: 10px;"> <p>ACS OFF</p> <p>Morse "E" & "T"</p> </div> </div> <div style="margin-top: 10px;"> <p>ACS ON</p> <p>Morse "E" & "T"</p> </div>

Contest Memory Keyer

The CW message capability of the FTDX101 may be controlled either from the Transceiver Front Panel, or with the optional FH-2 Remote Control Keypad, which plugs into the rear panel REM jack.

• Message Memory

Five CW memory channels capable of retaining 50 characters each are available (using the PARIS standard for characters and word length).

Example: CQ CQ CQ DE W6DXC K (19 characters)

--- · · · · · --- · · · · · --- · · · · · --- · · · · · --- · · · · · --- · · · · · --- · · · · · --- · · · · ·
C Q C Q C Q D E W 6 D X C K

• Storing a Message into Memory

1. Press the [FUNC] key.
2. Select [CW SETTING] → [KEYER].
3. Select the CW Memory Register (“CW MEMORY 1” to “CW MEMORY 5”) into which the message is to be stored; for now, the message entry technique is being set to “Keyer Entry” for the selected CW Memory register.
4. Set the selected CW Memory Register to “MESSAGE”. To use the Keyer Paddle for message entry on all the memories, set all five Menu items to “MESSAGE”.
5. Press the [FUNC] key to save the new setting and exit the Setting Menu.
6. Press the [FUNC] key to exit to normal operation.

• Message Memory Programming (Using your Paddle)

1. Set the operating mode to CW.
2. Be sure that Break-in is still turned “OFF” by the [BK-IN] key.
3. Press the [MIC/SPEED] knob. The indicator on the right side of the [MIC/SPEED] knob glows orange; and the built-in Electronic Keyer is activated. When using the optional FH-2 Controller, go to step 6.
4. Press the [FUNC] key.
5. Touch [REC/PLAY].
6. Touch [MEM] on the display or press the [MEM] key on the FH-2. A blinking “REC” will appear in the display.



If a Key [1] through [5] is not pressed within five seconds (see next step), the memory storage process will be cancelled.

7. Touch [1] through [5] on the display or press any of the FH-2 keys numbered [1] through [5] to select that memory storage register.
 - The “REC” will glow steadily.
 - If keying is not begun within ten seconds, the memory storage process will be cancelled.
8. Send the desired message using the keyer paddle.
9. Touch [MEM] on the display or press the [MEM] key on the FH-2 once more to end message recording.



Care must be exercised in sending to ensure the spaces between letters and words are accurately applied.

If the timing is off, the spacing may not be correct in the stored message. For ease in setting up the keyer memories, we recommend setting Menu item “F KEYER TYPE” (page 94) and/or “R KEYER TYPE” (page 95) to “ACS” (Automatic Character Spacing) while programming the keyer memories.

• **Checking the CW Memory Contents**

1. Be sure that Break-in is still turned “OFF” by the [BK-IN] key.
2. Press the [MONI] key to enable the CW monitor.

When using FH-2, go to step 5.

3. Press the [FUNC] key.
4. Touch [REC/PLAY] .
5. Touch [1] - [5] on the display or press the FH-2 [1] - [5] key, whichever memory was just recorded. The message will be played and heard in the sidetone monitor, but no RF energy will be transmitted.

- The “MSG” and “PLAY” icon will appear in the display.
- To adjust the volume level during playback, press and hold the [MONI] key then rotate the [MULTI] knob.

• **On-The-Air CW Message Playback**

1. Press the [BK-IN] key to enable transmission. When using FH-2, go to step 4.
2. Press the [FUNC] key.
3. Touch [REC/PLAY] .
4. Touch [1] - [5] on the display or press the FH-2 [1] - [5] key, to transmit the recorded CW Memory Register message. The programmed message will be transmitted on the air.

- During a transmission, the same key may be pressed again to immediately end the transmission.

Transmitting in the Beacon Mode

In “Beacon” mode, any programmed message, (either via Paddle, or via “Text” input method) may be repeatedly transmitted. The time delay between message repeats may be set from 1 to 60 seconds, in one second steps, via Menu item “REPEAT INTERVAL”.

To transmit the message:

1. Touch and hold [1] - [5] on the display or press and hold the FH-2 [1] - [5] key. Repetitive transmission of the Beacon message will begin.
2. Press the same key again to cancel the Beacon Mode.

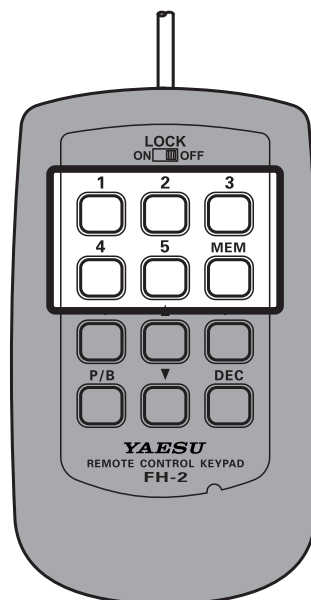

• TEXT Memory

The five channels of CW message memory (up to 50 characters each) may also be programmed using a text-entry technique.

This technique is somewhat slower than sending message directly from the keyer paddle, but accuracy of character spacing is ensured. Be sure to enter the character “}” at the end of the text message.

Example 1: CQ CQ CQ DE W6DXC K} (20 characters)

The sequential Contest Number (“Count up”) feature is another impressive feature of the CW Memory Keyer.

Example 2: 599 10 200 # K} (15 characters)

• Text Memory Storage

1. Press the [FUNC] key.
2. Select [CW SETTING] → [KEYER].
3. Select the CW Memory Register (“CW MEMORY 1” to “CW MEMORY 5”) into which a message is to be stored. For now, the message entry technique is being set to (Text entry) for the selected CW Memory Register.
4. If Text Message entry is to be used for all five memories, set all five CW Memory Register Menu items to “TEXT”.
5. Press the [FUNC] key to save the new setting and exit the Setting Menu.
6. Press the [FUNC] key to exit to normal operation.

Contest Number Programming

Use this process when starting a new contest, or if somehow the numbering gets out of sync during the contest.

1. Press the [FUNC] key.
2. Select [CW SETTING] → [KEYER] → [CONTEST NUMBER].
3. Rotate the [MULTI] knob to set the Contest Number to the desired value.
4. Press the [FUNC] key to save the new setting and exit the Setting Menu.
5. Press the [FUNC] key to exit to normal operation.

• Text Message Programming

1. Set the operating mode to CW.
When using the optional FH-2, go to step 4.
2. Press the [FUNC] key.
3. Touch [REC/PLAY].
4. Touch [MEM] on the display or press the [MEM] key on the FH-2.
5. Touch [1] through [5] on the display or press any of the FH-2 keys numbered [1] through [5] to select that memory storage register. The text input screen will appear.



The following texts are programmed to MEMORY 4 and MEMORY 5 in factory default.

MEMORY 4: DE FTDX101 K}

MEMORY 5: R 5NN K}

6. Touch the character keys on the display to enter the letters, numbers, or symbols of the desired label. Use the “#” character to designate the position where the Contest Number will appear.
7. When the message is complete, add the “}” character at the end to signify the termination of the message.

Example: CQ CQ CQ DE W6DXC K}



Use the FH-2 [◀] and [▶] keys to set the cursor position and use the FH-2 [▲] and [▼] keys to choose the letter/number to be programmed into each slot of the memory.

8. When the text entry is completed, touch [ENT].



9. When all the characters (including “}”) have been programmed, touch [BACK] to exit.

• **Checking the CW Memory Contents**

1. Set the operating mode to CW.
2. Be sure that Break-in is still turned “OFF” by the [BK-IN] key.
3. Press the [MONI] key to enable the CW monitor.
When using the optional FH-2, go to step 6.
4. Press the [FUNC] key.
5. Touch [REC/PLAY] .
6. Touch [1] - [5] on the display or press the FH-2 [1] - [5] key, whichever memory that was recorded in. The message will be played, and heard in the sidetone monitor, but no RF energy will be transmitted.
 - The “MSG” and “PLAY” icons will appear in the display.
 - To adjust the playback volume level, press and hold the [MONI] key then rotate the [MULTI] knob

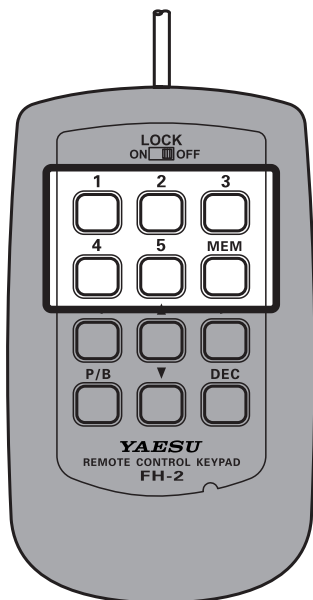

• **On-The-Air CW Message Playback**

1. Press the [BK-IN] key to enable transmission. When using FH-2, go to step 4.
2. Press the [FUNC] key.
3. Touch [REC/PLAY] .
4. Touch [1] - [5] on the display or press the FH-2 [1] - [5] key, depending on the CW Memory Register message to be transmitted. The programmed message will be transmitted on the air.
 - During transmission, press the same key again, to immediately cancel the transmission.

Transmitting in the Beacon Mode

In “Beacon” mode, any programmed message, (either via Paddle, or via “Text” input method) may be repeatedly transmitted. The time delay between message repeats may be set from 1 to 60 seconds, in one second steps, via Menu item “REPEAT INTERVAL”.

To transmit the message:

1. Touch and hold [1] - [5] on the display or press and hold the FH-2 [1] - [5] key. Repetitive transmission of the Beacon message will begin.
2. Press the same key again to cancel the Beacon Mode.

Contest Number

If “#” is entered in the CW message, the contest number will automatically increment (count up) each time the message is sent. See below to set the contest number.

Contest Number Programming

1. Press the [FUNC] key.
2. Select [CW SETTING] → [KEYER] → [CONTEST NUMBER].
3. Rotate the [MULTI] knob to set the Contest Number to the desired value.
4. Press the [FUNC] key to save the new setting and exit the Setting Menu.
5. Press the [FUNC] key to exit to normal operation.

Decrementing the Contest Number

Use this process if the current contest number gets ahead of the actual number. For example: in case of a duplicate QSO,).

Press the FH-2 [DEC] key momentarily. The current Contest Number will be reduced by one. Press of the FH-2 [DEC] key as many times as necessary to reach the desired number. If you go too far, use the “Contest Number Programming” technique described above.

FM Mode Operation

Repeater Operation

The FTDX101 may be operated on 29 MHz and 50 MHz repeaters.

1. Press and hold the [MODE] key, and then touch [FM].
2. Set to the desired repeater's output frequency (downlink from the repeater).
3. Press the [FUNC] key.
4. Touch [RPT] .
5. Rotate the [MULTI] knob to select the desired repeater shift direction. The selections are:
"SIMP" → "+" → "-" → "SIMP"
 - To program the proper repeater shift, use Menu items "RPT SHIFT(28MHz)" (page 88) and "RPT SHIFT(50MHz)" (page 88), as appropriate.
6. Press the [FUNC] key.
7. Touch [ENC/DEC] .
8. Rotate the [MULTI] knob to select "ENC".
9. Press the [FUNC] key.
10. Touch [TONE FREQ] .
11. Rotate the [MULTI] knob to select the desired CTCSS Tone to be used. A total of 50 standard CTCSS tones are provided (see the CTCSS Tone Chart).

Press and hold the microphone PTT switch to begin transmission.

Tone Squelch Operation

The "Tone Squelch" may be activated to keep the receiver silent until an incoming signal modulated with a matching CTCSS tone is received. The receiver squelch will then open in response to reception of the required tone.

1. Press and hold the [MODE] key, and then touch [FM].
2. Set the transceiver to the desired frequency.
3. Press the [FUNC] key.
4. Touch [ENC/DEC] .
5. Rotate the [MULTI] knob to select "TSQ".
6. Press the [FUNC] key.
7. Touch [TONE FREQ] .
8. Rotate the [MULTI] knob to select the desired CTCSS Tone to be used. A total of 50 standard CTCSS tones are provided (see the CTCSS Tone Chart).

CTCSS Tone Frequency (Hz)											
67.0	69.3	71.9	74.4	77.0	79.7	82.5	85.4	88.5	91.5	94.8	97.4
100.0	103.5	107.2	110.9	114.8	118.8	123.0	127.3	131.8	136.5	141.3	146.2
151.4	156.7	159.8	162.2	165.5	167.9	171.3	173.8	177.3	179.9	183.5	186.2
189.9	192.8	196.6	199.5	203.5	206.5	210.7	218.1	225.7	229.1	233.6	241.8
250.3	254.1	-	-	-	-	-	-	-	-	-	-

RTTY (FSK) Operation

The FTDX101 is equipped with a RTTY decode function. The RTTY signal may be easily synchronized by aligning the marker displayed on the TFT screen.

Mark frequency (2125 Hz), SHIFT width (170 Hz), and baudot code (US) can be changed in the Setting Menu.

Connecting to a Personal Computer

Connect the transceiver and a PC with a commercially available USB cable (A-B) to operate RTTY using commercially available software and freeware.



To connect to a PC using a USB cable, a Virtual COM port driver must be installed on the PC. Visit the Yaesu website <http://www.yaesu.com/> to download the Virtual COM port driver and Installation Manual.

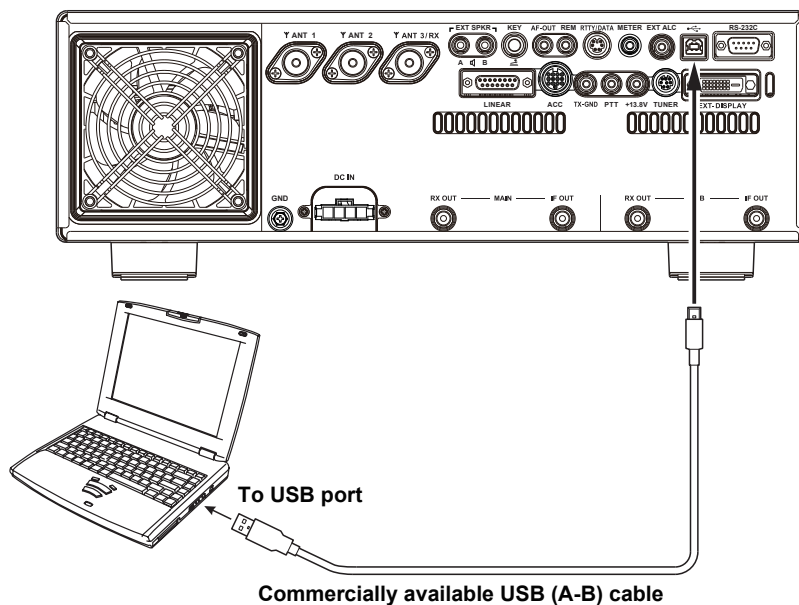

Connecting to the TU (Terminal Unit)

Connect the RTTY communications TU (Terminal Unit) to the rear panel RTTY/DATA terminal. Be sure to read the instruction manual of the TU device before connecting it.

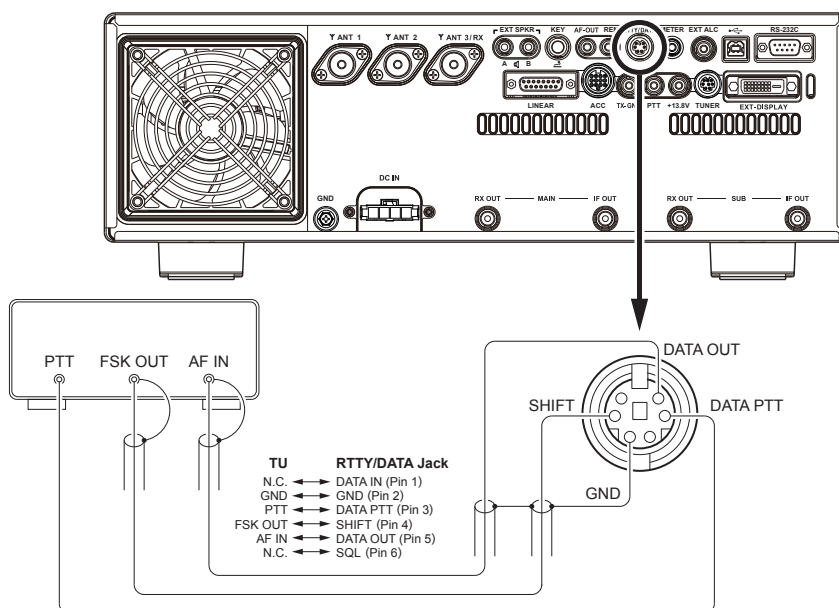

RTTY Decode

The received RTTY signal is decoded and the text is presented on the TFT display.

! Cross talk, noise, phasing, etc. may prevent accurate decoding and display of the RTTY text.

1. Before operating with RTTY, set the Menu items in the chart to the below.

Setting Menu	Available Values (Bold is the default)	
RADIO SETTING → MODE RTTY → RPTT SELECT	DAKY	Controls the RTTY transmit signal from the RTTY/DATA jack (pin 4) on the rear panel.
	RTS/DTR	Controls the RTTY transmit signal from the USB virtual COM/RTS or DTR ports.
RADIO SETTING → MODE RTTY → POLARITY RX	NOR	The shift direction of the RTTY receive space frequency will be lower than the mark frequency.
	REV	The shift direction of the RTTY receive mark frequency will be lower than the space frequency.
RADIO SETTING → MODE RTTY → POLARITY TX	NOR	The shift direction of the RTTY transmit space frequency will be lower than the mark frequency.
	REV	The shift direction of the RTTY transmit mark frequency will be lower than the space frequency.
RADIO SETTING → MODE RTTY → RTTY OUT SELECT	MAIN SUB	RTTY operating band setting.
RADIO SETTING → MODE RTTY → MARK FREQUENCY	1275Hz 2125Hz	Normally use at 2125 Hz.
RADIO SETTING → MODE RTTY → SHIFT FREQUENCY	170Hz 200Hz 425Hz 850Hz	Normally use at 170 Hz.

2. Press and hold the [MODE] key, then touch "RTTY-L".

i Generally, amateur band stations operate RTTY in LSB.

Align the peak of the received signal with the mark frequency and shift frequency marker of the TFT screen.

3. Press the [FUNC] key.

4. Touch "DECODE".

The RTTY DECODE screen will appear, and the decoded text is displayed on the screen.

Displays the decoded RTTY text.

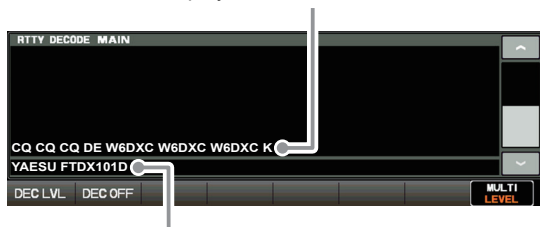

Displays text entered into the RTTY sending memory.

- When a RTTY signal is not being received, scrambled characters may be displayed due to noise and band clutter. The threshold level can be adjusted so the scrambled text is not displayed.
- To decode a signal received in the SUB band, set the setting menu "DECODE RX SELECT" (page 97) to "SUB".

Threshold Level Adjustment

1. Touch [DEC LVL] on the lower left side of the RTTY decode screen.
2. Rotate the [MULTI] knob, and adjust the threshold level (between 0 and 100) so scrambled text is not displayed.
Note that text will no longer be displayed for weak signals if the level is increased too much.
3. The setting is concluded when 4 seconds have elapsed after making the level adjustment.

RTTY Text Memory

Five phrases (up to 50 characters each) frequently used in RTTY exchanges can be entered into the Text Memory, either by operation on the TFT screen, or by using the optional “FH-2” Remote Control Keypad connected to the rear panel REM jack.

5 channels can be memorized, and the memory content can be transmitted by operation on screen or the FH-2.

• Text Message Programming on TFT Screen

1. Press and hold the [MODE] key, then touch “RTTY-L”.
2. Press the [FUNC] key, then touch [REC/PLAY]. The “RTTY MESSAGE MEMORY” screen will appear.



3. Touch [MEM].
A blinking “REC” will appear in the display. If no entry is made within 5 seconds, the registration operation will be cancelled.
4. Touch [1] through [5] to select the desired RTTY Text Memory Register into which the text is to be programmed.
The text input screen will appear.
5. Continue with “Text Input” below:

• Text Input

1. Enter the letters, numbers, or symbols with the touch character keys on the TFT display or use a USB keyboard connected to the USB port on the transceiver front panel. Use the FH-2 [◀] and [▶] keys to move the cursor position and use the FH-2’s [▲] and [▼] keys to select the letter/number to be entered for each character of the memory.



When the message is complete, add the “J” character (touch [End]), to complete the entry.



The following texts are programmed to the MEMORY 4 and MEMORY 5 in factory default.
MEMORY 4: DE FTDX101 KJ
MEMORY 5: R 5NN KJ

2. Touch [ENT] or press and hold the [MEM] key on the FH-2 to exit, after all characters (including “J”) have been programmed.



• Text Message Programming on FH-2 Remote Controller

1. Press and hold the [MODE] key, then touch “RTTY-L”.
2. Press the [MEM] key on the FH-2.
A blinking “REC” will appear in the display. If no entry is made within 5 seconds, the registration operation will be cancelled.
3. Press any of the FH-2 keys numbered [1] through [5] to select that memory storage register.
The text input screen will appear.
4. Continue with “Text Input”.

• On-The-Air RTTY Text Message Playback

Operation on TFT screen

1. Press the [FUNC] key.
2. Touch [REC/PLAY].
The “RTTY MESSAGE MEMORY” screen will appear.



3. Touch [1] through [5] key, depending on which RTTY Text Memory Register message is to be transmitted. The programmed message will be transmitted on the air.
Touch the same number again to immediately cancel the transmission.

Operation with FH-2 Controller

Press the FH-2 [1] through [5] key, depending on which RTTY Text Memory Register message is to be transmitted. The programmed message will be transmitted on the air.

Press the same number again to immediately cancel the transmission.



Adjust the RTTY data output level using Menu item [RADIO SETTING] → [MODE RTTY] → [RTTY OUT LEVEL] (page 90).

DATA (PSK) Operation

The FTDX101 PSK Decode Feature supports both BPSK and QPSK with error correction functions. Easily synchronize PSK by aligning the marker on the TFT display screen.

Connecting to a Personal Computer

Connect the transceiver and a PC with a commercially available USB cable (A-B) to perform PSK data communications using commercially available software and freeware.



To connect to a PC using a USB cable, a Virtual COM port driver must be installed on the PC. Visit the Yaesu website <http://www.yaesu.com/> to download the Virtual COM port driver and Installation Manual.

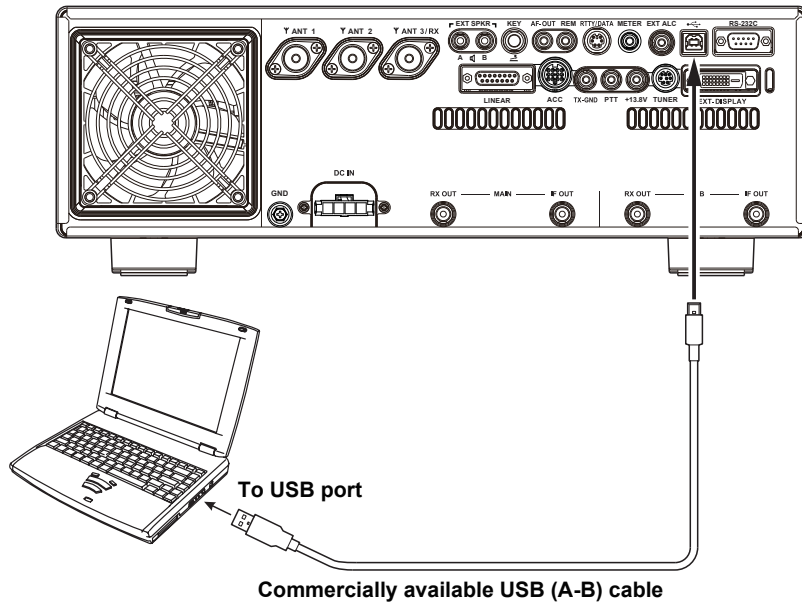

Connecting to the Data Communications Device

A Data Communications Device may be connected to the rear panel RTTY/DATA terminal. Be sure to read the instruction manual of the Data Communications Device before connecting it.

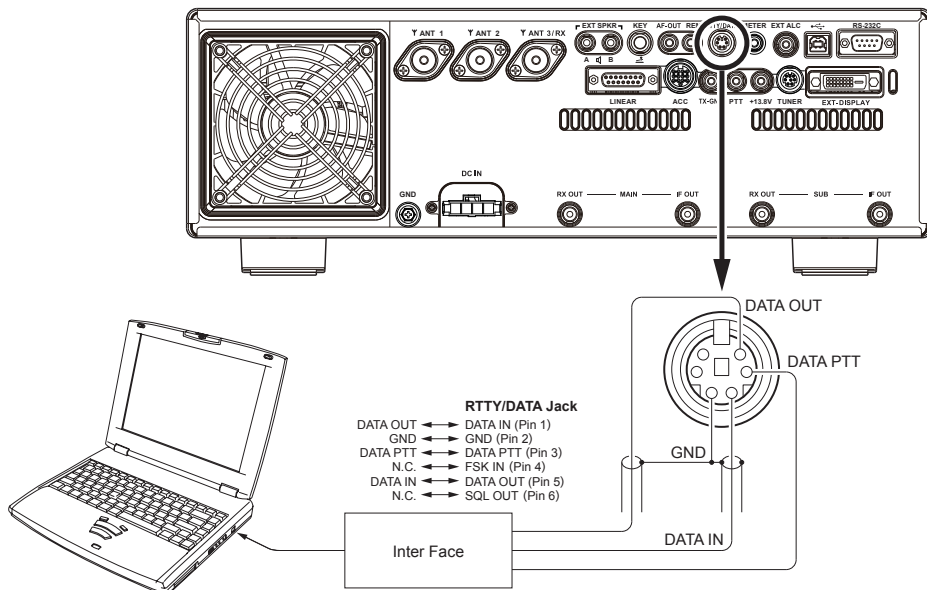

PSK Decode

The received PSK signal is decoded and presented in text on the TFT display.

! Cross talk, noise, phasing, etc., may cause scrambled characters to be displayed.

1. For PSK operation, set the Menu items as indigitated in the below chart.

Setting Menu	Available Values (Bold is the default)	
RADIO SETTING → MODE PSK/DATA → DATA MODE SOURCE	MIC	DATA is input from the MIC jack on the front panel.
	REAR	DATA is input from the USB jack or RTTY/DATA jack on the rear panel.
RADIO SETTING → MODE PSK/DATA → RPTT SELECT	DAKY	Controls the DATA transmit signal from the RTTY/DATA jack (pin 4) on the rear panel.
	RTS/DTR	Controls the DATA transmit signal from the USB virtual COM/RTS or DTR ports.
RADIO SETTING → MODE PSK/DATA → REAR SELECT	DATA	Inputs the transmission data from the RTTY/DATA jack (pin 1) on the rear panel.
	USB	Inputs the transmission data from the USB Jack on the rear panel.
RADIO SETTING → MODE PSK/DATA → DATA OUT SELECT	MAIN SUB	PSK/DATA signal output Band setting.
RADIO SETTING → ENCDEC PSK → PSK MODE	BPSK	THIS is the standard mode. Normally use BPSK mode.
	QPSK	QPSK incorporates error correction function.

2. Press and hold the [MODE] key, then touch "PSK".

Align the peak of the received signal with the mark frequency and shift frequency marker of the TFT screen.

3. Press the [FUNC] key.

4. Touch "DECODE".

The PSK DECODE screen will appear, and the decoded text is displayed on the screen.

Displays the PSK signal decoded.

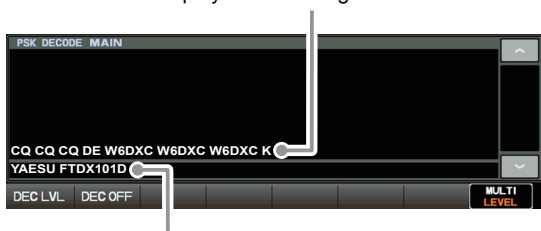

Displays content written to the PSK text memory.

Threshold Level Adjustment

1. Touch [DEC LVL] on the lower left side of the PSK decode screen.
2. Rotate the [MULTI] knob, and adjust the threshold level (between 0 and 100) so scrambled characters are not displayed.
Note that text will no longer be displayed for weak signals if the level is increased too much.
3. The setting is concluded when 4 seconds have elapsed after making the level adjustment.

- Set the data output level for data communications using Menu item "DATA OUT LEVEL" (page 89).
- When a signal is input, it can be automatically sent using Menu item "VOX SELECT" (page 102).
- Set data input VOX gain in VOX operation for data communications using Menu item "DATA VOX GAIN" (page 102).
- To decode a signal received in the SUB band, set the setting menu "DECODE RX SELECT" (page 97) to "SUB".

PSK Text Memory

Five phrases (up to 50 characters each) frequently used in PSK exchanges can be entered into the Text Memory, either by operation on the TFT screen, or by using the optional “FH-2” Remote Control Keypad connected to the rear panel REM jack.

5 channels can be recorded. The memory content can be transmitted by operation on screen or the FH-2.

• Text Message Programming on TFT Screen

1. Press and hold the [MODE] key, then touch “PSK”.
2. Press the [FUNC] key, then touch [REC/PLAY].
The “PSK MESSAGE MEMORY” screen will appear.



3. Touch [MEM].
A blinking “REC” will appear in the display. If no entry is made within 5 seconds, the registration operation will be cancelled.

• Text Input

1. Enter the letters, numbers, or symbols with the touch a character keys on the display or the USB keyboard connected to the USB port on the front panel.
Use the FH-2 [◀] and [▶] keys to set the cursor position, and use the FH-2's [▲] and [▼] keys to choose the letter or number to be programmed for each character of the memory.



When the message is complete, add the “↵” (touch [End]) character at the end to signify the completion of the message.



The following texts are programmed to the MEMORY 4 and MEMORY 5 in factory default.

MEMORY 4: DE FTDX101 K↵
MEMORY 5: R 5NN K↵

2. Touch [ENT] to exit, once all characters (including “↵”) have been programmed.



4. Touch [1] through [5] to select the desired PSK Text Memory Register into which the text is to be programmed.
The text input screen will appear.
5. Continue with “Text Input” below.

• Text Message Programming on FH-2 Remote Controller

1. Press and hold the [MODE] key, then touch “PSK”.
2. Press the [MEM] key on the FH-2.
A blinking “REC” will appear in the display. If no entry is made within 5 seconds, the registration operation will be cancelled.
3. Touch [1] through [5] on the display or press any of the FH-2 keys numbered [1] through [5] to select that memory storage register.
The text input screen will appear.
4. Continue with “Text Input”.

• On-The-Air PSK Text Message Playback

Operation on TFT screen

1. Press the [FUNC] key.
2. Touch [REC/PLAY].
The “PSK MESSAGE MEMORY” screen will appear.



3. Touch [1] through [5] key, depending on which PSK Text Memory Register message you wish to transmit. The programmed message will be transmitted on the air.
Touch the same number again during transmission, transmission will be canceled.

Operation with FH-2 Controller

Press the FH-2 [1] through [5] key, depending on which PSK Text Memory Register message you wish to transmit.

The programmed message will be transmitted on the air.

Press the same number again during to immediately cancel the transmission.



Adjust the data output level using Menu item [RADIO SETTING] → [MODE PSK/DATA] → [DATA OUT LEVEL] (page 102).

Memory Operation

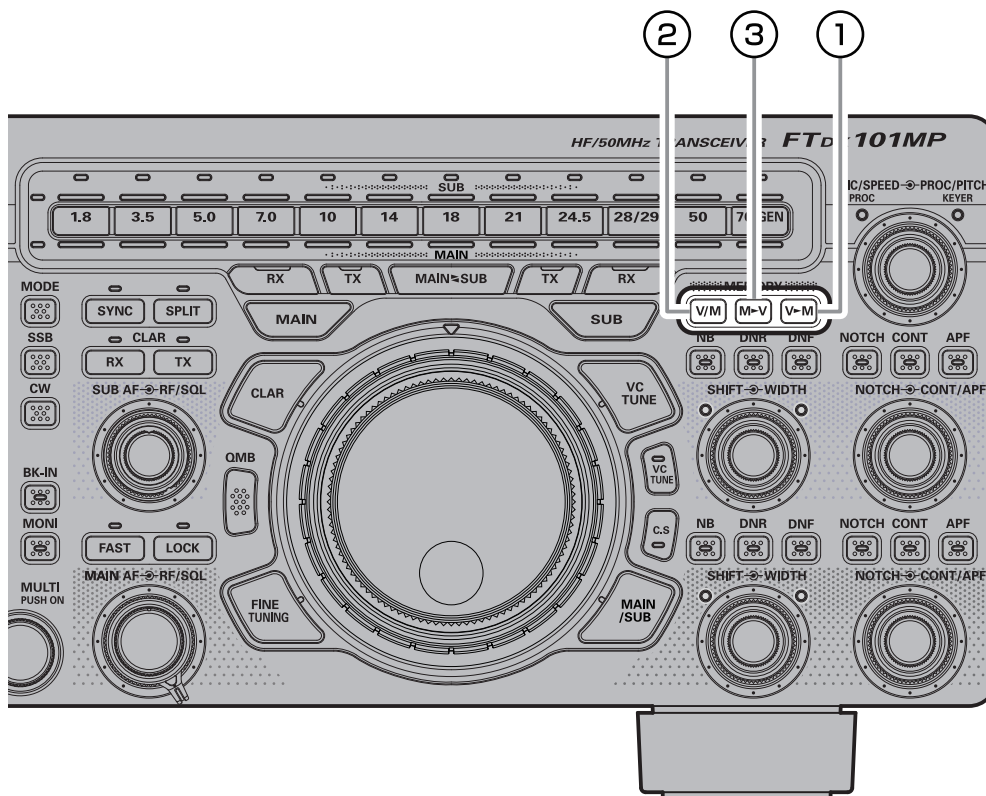

① V▶M

• Memory Storage

1. Set the frequency, mode, and status, as desired.
2. Press the [V▶M] key.
The memory channel list will be displayed.
3. From the channel list, touch and select the desired memory channel
Alternately, the memory channel may be selected by rotating the [MULTI] knob.



4. Press and hold the [V▶M] key to store the frequency and other data into the selected memory channel.
 - This method may also be used to overwrite the contents previously stored to a memory channel.
5. Press the [V▶M] key, the memory is stored and the screen returns normal.



The information saved in the memory may be lost due to incorrect operation, static electricity or electrical noise. Data may also be lost due to component failures and repairs. Make sure to write down the information registered in the memories on a piece of paper or by using a SD card (page 81).

• Erasing Memory Channel Data

The contents written to the memory channel may be erased.

1. Press the [V▶M] key.
The memory channel list will be displayed.
2. From the channel list, touch and select the memory channel to be erased.
Alternately, the memory channel may be selected by rotating the [MULTI] knob.
3. Touch [ERASE] to clear the contents of the selected memory channel.



4. Press the [V▶M] key to erase the contents of the selected memory channel.



If you make a mistake and wish to restore a memories contents, touch [RESTORE].



Memory channels "M-01" (and "5-01" through "5-10": U.S. version) cannot be erased.

• Check Memory Channel Status

Before programming a memory channel, the current contents of that channel may be verified without the danger of over-writing the channel.

1. Press the [V►M] key.
The memory channel list will be displayed.



2. From the channel list, touch and select the memory channel and check, or change the operation mode.
Alternately, the memory channel may be selected by rotating the [MULTI] knob.
 - Press the [MULTI] knob to enter memory mode on the selected channel.
3. To change the operation mode, touch [MODE], rotate the [MULTI] knob to select the mode then press the [MULTI] knob.



4. [WRITE] will turn orange, so touch [WRITE].
5. The channel list changes, and the selected memory channel on the list is framed in orange.
6. Press the [V►M] key to return to the previous screen.

② V/M

This key toggles frequency control between VFO and the memory system.



The contents of the memory channels can be recalled and used later.

• Recall a Memory Channel other than the last used VFO frequency

1. Press and hold the [V/M] key.
The memory channel list will be displayed.



2. From the channel list, touch and select the desired memory channel.
Alternately, the memory channel may be selected by rotating the [MULTI] knob.
3. Press the [MULTI] knob

Memory channels can also be called up in the following method.



1. Press the [V/M] key.
2. Press the [FUNC] key.
3. Touch [MEM CH].

Rotate the [MULTI] knob to select the desired memory channel.

- While using the recalled memory, the stored frequency and operating mode can be changed temporarily (see “Memory Tune Operation” below).
4. To exit from memory mode and return to the VFO mode, press the [V/M] key.



If a memory group is set, the channels stored in the selected memory group may be recalled.

• Memory Tune Operation

You may freely tune off from any memory channel in a “Memory Tune” mode, this is similar to VFO operation. So long as you do not over-write the contents of the current memory, Memory Tune operation will not alter the contents of the memory channel.

- The “**MT**” notation will appear instead of the “M-nn”.

Press the [V/M] key to return to the originally memorized frequency of the current memory channel.

③ M▶V

• Moving Memory Data to the VFO register

The contents of the currently selected Memory Channel may be transferred into the VFO register:

1. Press the [M▶V] key While operating in either VFO mode, or memory channel mode, to transfer memory channel data to the VFO. The memory channel list will be displayed.
2. From the channel list, touch the memory channel to select it and transfer it to the VFO. Alternately, the memory channel may be selected by rotating the [MULTI] knob.
3. Press the [M▶V] key. The data in the selected memory channel will now be transferred to VFO.

• Labeling Memories

Alphanumeric labels (“Tags”) may be appended to memory channels, to aid in recollection of the channel’s use (such as a club name, a location etc.).

1. Press the [V▶M] key. The memory channel list is displayed.
2. From the channel list, touch and select the desired memory channel. Alternately, the memory channel may be selected by rotating the [MULTI] knob.
3. Touch [NAME] area on the screen. The character input screen will be displayed.
4. Touch a character key on the display to enter the letters, numbers, or symbols of the desired label.

Up to 12 characters may be used in the creation of a label.



5. Touch [ENT] .
6. [WRITE] will turn orange, then touch [WRITE].

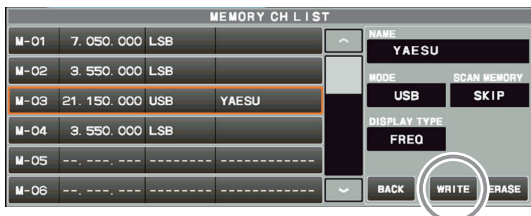

7. The entered characters are confirmed, and the selected memory channel on the list is framed in orange. To add a label to another memory, repeat steps 2 to 7 above.
8. Press the [V▶M] key to save the new settings and return to normal operation.

• Displaying the Memory Tag

The “Frequency display” or “Alpha tag display” format may be selected.

1. Press the [V▶M] key. The memory channel list will be displayed.
2. From the channel list, touch and select the desired memory channel. Alternately, the memory channel may be selected by rotating the [MULTI] knob.
3. Touch [DISPLAY TYPE] area.



4. Rotate the [MULTI] knob to select the desired display type.

FREQ	Frequency
NAME	Memory Tag

5. [WRITE] will turn orange, then touch [WRITE].
6. The data is saved to the new setting, and the selected memory channel on the list is framed in orange.
7. Press the [V▶M] key to save the new setting and return to normal operation.

• Scan Skip Setting

The “Frequency display” or “Name display” format may be selected.

1. Press the [V▶M] key. The memory channel list will be displayed.
2. From the channel list, touch and select the Memory Channel to be skipped during scanning. Alternately, the memory channel may be selected by rotating the [MULTI] knob.
3. Touch [SCAN MEMORY] area.



4. Rotate the [MULTI] knob to select “SKIP”, then press the [MULTI] knob.
5. [WRITE] will turn orange, then touch [WRITE].
6. The data is saved to the new setting, and the selected memory channel on the list is framed in orange.
7. Press the [V▶M] key to save the new setting and return to normal operation.

i To re-institute a channel into the scanning loop, select “SCAN” in step 4 above.

Memory Groups

Memory channels may be listed into as many as six convenient groups, for easy identification and selection. For example: groups for AM BC stations, Short-wave broadcast stations, Contest frequencies, Repeater frequencies, PMS limits, or any other desired grouping may be created.

Each memory group may hold up to 20 memory channels (except Memory Group 01 which is limited to 19 memory channels). When memory channels are grouped, the channel numbers change to correspond to the chart below:

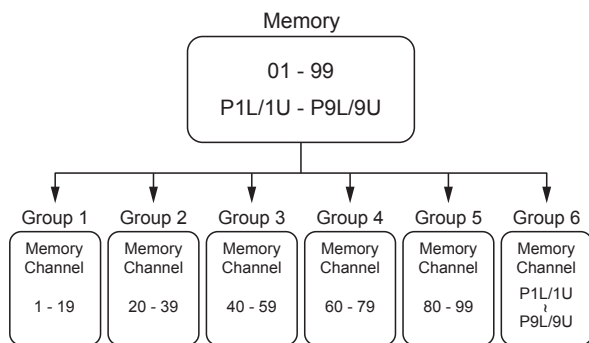

1. Press the [FUNC] key.
2. Select [OPERATION SETTING]→[GENERAL]→[MEM GROUP].
3. Select [ON].
4. Press the [FUNC] key to save the new setting and exit the Setting Menu.
5. Press the [FUNC] key to exit to normal operation.
 - To cancel Memory Group operation, repeat steps 1 through 5 above, choosing "OFF" in step 3.

Choosing the Desired Memory Group

If desired, just the memories listed within a particular Memory Group, may be recalled.



Before performing the operation, set the "MEM GROUP" menu to "ON" (Refer to "Memory Groups" setting on the left).

1. Press the [V/M] key, if necessary, to enter the "Memory" mode.
2. Press the [FUNC] key.
3. Touch [GROUP].
4. Rotate the [MULTI] knob to select the desired Memory Group, then press the [MULTI] knob.
5. Press the [FUNC] key, then touch [MEM CH].
6. Rotate the [MULTI] knob to select the desired Memory Channel within the Selected Memory Group.

VFO and Memory Scanning

Either the VFO or the memory channels of the FTDX101 may be scanned, and the receiver will halt scanning on any frequency with a signal strong enough to open the receiver squelch.

In the SSB/CW and SSB-based Data modes, the decimal points in the frequency display area will blink and the scanner will slow down (but does not stop).

VFO/Memory Scan

1. Set the frequency or Memory channel at which scanning is to begin.
2. Rotate the [RF/SQL] knob so that the background noise is just silenced (page 42, 43).

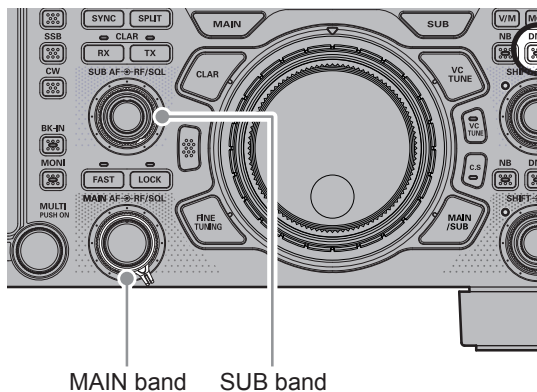

3. Press the [FUNC] key.
4. Touch [SCAN] to start scanning.
 - You can start scanning by pressing and holding the UP or DWN key on the microphone.
 - If the scanner halts on an incoming signal, the decimal point between the “MHz” and “kHz” digits of the frequency display will blink.
 - The operation when a signal is received during scanning varies depending on the mode type.

Other than SSB, CW	Scanning will pause.
SSB, CW	Scanning speed will be slower, but scanning will not be paused.

- If the scan has paused on a signal, pressing the microphone UP or DWN button will cause scanning to resume instantly.
- If the Main Tuning Dial knob is rotated while scanning is in progress, the VFO scanning or memory channel scanning will continue up or down in accordance with the direction of the Dial Knob rotation. (In other words, if the dial is rotated to the left when scanning toward a higher frequency or memory channel number, the direction of the scan will reverse.)

To cancel scanning, press the PTT switch, or press any key on the front panel of the transceiver.

If the microphone PTT button is pressed during scanning, the scanner will halt at once. However, pressing the PTT button while scanning will not cause transmission.

- If you have no interest in scanning, and wish to prohibit the microphone UP/DWN buttons from initiating scanning, you may disable scanning control from the microphone using Menu item [OPERATION SETTING] → [GENERAL] → [MIC SCAN] (page 98).
- During Memory Group operation, only the channels within the current Memory Group will be scanned.
- The manner in which the scanner resumes after it has paused on a signal may be selected by using Menu item [OPERATION SETTING] → [GENERAL] → [MIC SCAN RESUME] (page 98).

The default “TIME” (5 sec) setting will cause the scanner to resume scanning after five seconds; however the scan setting may be changed to resume only after the received signal has dropped out.

Programmable Memory Scan (PMS)

To limit scanning (and manual tuning) to a particular frequency range, the Programmable Memory Scanning (PMS) feature utilizes nine special-purpose memory pairs (“M-P1L/M-P1U through M-P9L/ M-P9U). The PMS feature is especially useful in helping to observe any operating sub-band limits which apply to your Amateur license class.

First: store the Lower and Upper tuning/scanning limit frequencies into the memory pair “M-P1L” and “M-P1U”, respectively (or any other “L/U” pair of special PMS memories).

1. Recall the memory channel "M-P1L".
2. Rotate the [RF/SQL] knob so that the background noise is just silenced (page 42, 43).

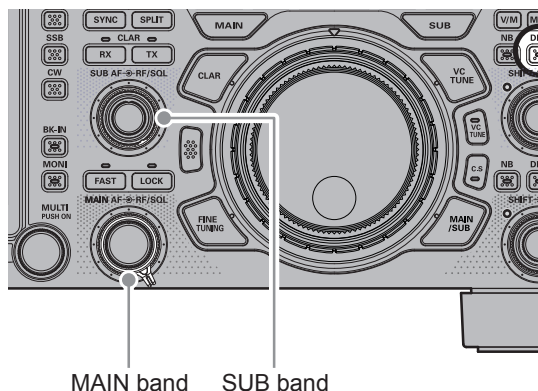

3. Turn the Main Dial knob slightly (to activate memory tuning).
 - The Memory Channel “M-PL1” will be replaced by “**PMS**”.
4. Press the [FUNC] key.
5. Touch [SCAN] to start PMS.
 - Scanning is only between frequencies stored in M-P1L and M-P1U.
 - Start scanning by pressing and holding the UP or DWN key on the microphone.
 - The operation when a signal is received during scanning varies depending on the mode type.

Other than SSB, CW	Scanning will pause.
SSB, CW	Scanning speed will be slower, but scanning will not be paused.

- If the scan has paused on a signal, pressing the microphone UP or DWN button will cause scanning to resume instantly.
- If the Main Tuning Dial knob is rotated while scanning is in progress, the scanning will continue up or down in frequency according to the direction of the Dial Knob rotation. (in other words, if the dial is rotated to the left when scanning toward a higher frequency, the direction of the scan will reverse.)

To cancel scanning, press the PTT switch, or press any key on the front panel of the transceiver.

If the microphone PTT button is pressed during scanning, the scanner will halt at once. However, pressing the PTT button while scanning will not cause transmission.

- If you have no interest in scanning, and wish to prohibit the microphone UP/DWN buttons from initiating scanning, you may disable scanning control from the microphone using Menu item [OPERATION SETTING] → [GENERAL] → [MIC SCAN] (page 98).
- The manner in which the scanner resumes after it has paused on a signal may be selected by using Menu item [OPERATION SETTING] → [GENERAL] → [MIC SCAN RESUME] (page 98).
The default “TIME” (5 sec) setting will cause the scanner to resume scanning after five seconds; however the scan setting may be changed to resume only after the received signal has dropped out.

Other Functions

Band Stack Operation

The FTDX101 employs a triple band-stack VFO selection technique that permits storing up to three favorite frequencies and modes onto each band VFO register.

A typical setup, for the 14 MHz band, might be arranged like this:

1. Program 14.0250 MHz, CW Mode, then press the [14] key.
2. Program 14.0800 MHz, RTTY Mode, then press the [14] key.
3. Program 14.1950 MHz, USB Mode, then press the [14] key.

With this configuration, successive momentary presses of the [14] MHz band key will step sequentially through these three VFOs.

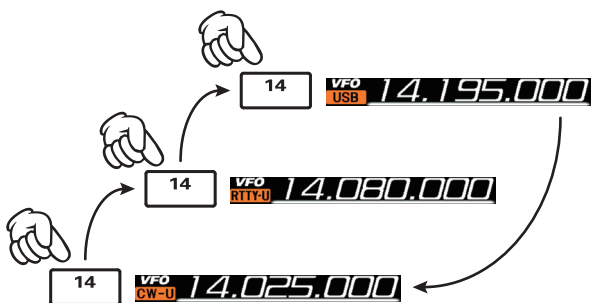

TOT (Time Out Timer)

The “Time-Out Timer” (TOT) shuts the transmitter OFF after continuously transmitting for the programmed time.

1. Press the [FUNC] key.
2. Select [OPERATION SETTING]→[GENERAL]→[TX TIME OUT TIMER].
3. Rotate the [MULTI] knob to select the TOT countdown time (1 -30 min or OFF).
4. Press the [FUNC] key to save the new setting and exit the Setting Menu.
5. Press the [FUNC] key to exit to normal operation.



The beep sounds at about 10 seconds before returning to receive mode automatically.

[MULTI] knob Step Increment Setting

The [MULTI] knob may be set to turn in preset frequency steps.

1. Press the [FUNC] key.
2. Touch [STEP DIAL].
3. Rotate the [MULTI] knob.
 - Pressing the [FAST] key engages the “Fast” tuning selection.
 - The amount of frequency change depends on the operating mode (default setting: see table below).

Operating Mode	1 Step
SSB / CW / RTTY / PSK DATA-L / DATA-U	2.5 kHz [25 kHz]*
AM / FM DATA-FM	5 kHz [50 kHz]*

*Numbers in parentheses indicate steps when the [FAST] key is On.

- The frequency steps can be changed in the Setting Menu.

Operating Mode	Memu Item	Step (kHz)
SSB / CW RTTY / PSK DATA-L / DATA-U	CH STEP (page 103)	1 / 2.5 / 5
AM	AM CH STEP (page 103)	2.5 / 5 / 9 / 10 / 12.5 / 25
FM DATA-FM	FM CH STEP (page 103)	5 / 6.25 / 10 / 12.5 / 20 / 25

Operation on Alaska Emergency Frequency: 5167.5 kHz (U.S. Version Only)

Section 97.401(d) of the regulations governing amateur radio in the United States permit emergency Amateur communications on the spot frequency of 5167.5 kHz by stations in (or within 92.6 km of) the state of Alaska. This frequency is only to be used when the immediate safety of human life and/or property are threatened, and is never to be used for routine communications.

The FTDX101 is capable of transmitting and receiving on 5167.5 kHz under such emergency conditions. Use the Setting Menu to activate the Alaska Emergency Frequency feature:

1. Press the [FUNC] key.
2. Select [OPERATION SETTING]→[TX GENERAL]→[EMERGENCY FREQ TX].
3. Select "ON".
4. Press the [FUNC] key to save the new setting and exit the Setting Menu.
5. Press the [FUNC] key to exit to normal operation. Emergency communication on this spot frequency is now possible.
6. Press the [V/M] key, as necessary, to enter the Memory mode.
7. Press the [FUNC] key, then touch [MEM CH].
8. Rotate the [MULTI] knob to select the emergency channel ("EMG"), which is found between channels "5-10" and "M-01".

Screen capture

The display on the TFT screen may be saved on the SD card.



When performing screen capture, a commercially available SD card is necessary.

For SD card information, refer to "Using the SD Card" on page 80.

1. Insert the SD card into the SD card slot.

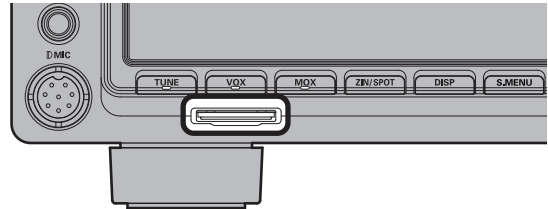

2. Display the screen that is to be saved.
3. Hold down the [FUNC] key until "SCREEN SHOT" appears on the screen. Screen data is saved to the SD card.

Data saved on the SD card can be displayed on a personal computer or similar viewer.

data form	bmp (Bitmap format)
Image size	800×480
File Name	yyyyymmdd_hhmmss.bmp The captured date and time will be the file name. y (year), m (month), d (day), h (hour), m (minute), s (second)
Data storage location	"Capture" folder Folder structure in SD card FTDX101 ├── Capture ├── MemList └── Menu

Using the SD Card

The following operations can be completed with the use of an SD card in the transceiver:

- Saving the Memory Channel information
- Saving the Set-up Mode settings
- Transceiver firmware update
- Save a screen capture of the TFT display

• SD Cards that can be used

YAESU has tested with the 2GB SD card, and 4GB, 8GB, 16GB and 32GB SDHC cards, most can be used in this radio.

Please format (initialize) the SD card used for the first time on this unit with this transceiver.

- i**
- The SD or SDHC cards are not provided with the product.
 - Not all SD and SDHC cards sold commercially are guaranteed to work with this product.

- !**
- Do not touch the contacts of the SD card with your hands.
 - SD memory cards formatted on other devices may not properly save information when used with this transceiver. Format SD memory cards again with this transceiver when using memory cards formatted with another device.
 - Do not remove the SD memory card or turn the transceiver OFF, while saving data to a SD memory card is in progress.
 - When a single SD card is used for a long period of time, writing and deletion of data may become disabled. Use a new SD card when data can no longer be written or erased.
 - Note that Yaesu shall not be liable for any damages suffered as a result of data loss or corruption in use of the SD card.

• Installing the SD card

1. Turn OFF the transceiver.
Insert the SD card into the SD card slot, with the contact face on the bottom, until a click sound is heard.

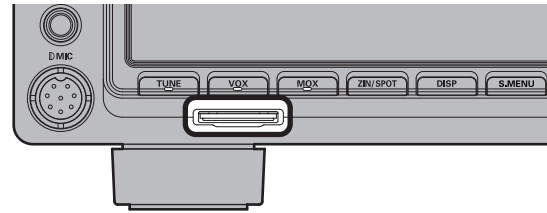

• Removing the SD card

1. Turn OFF the transceiver.
2. Push in on the SD card.
A click sound will be heard and the SD card will be pushed outward.

• Formatting a SD card

When using a new SD card, format it according to the following procedure.

- !**
- Formatting a microSD memory card erases all data saved on it. Before formatting the microSD memory card, be sure to check the data previously saved on it.

1. Press the [FUNC] key.
2. Select [EXTENSION SETTING] → [SD CARD].
3. Touch "DONE" on the "FORMAT" item.
The format confirmation screen will be displayed.
4. Touch "START", the SD card will be initialized. Touch "BACK" to cancel the initialization.
5. "FORMAT COMPLETED" will be displayed when initialization is completed.
6. Touch the screen to end formatting.
7. Press the [FUNC] key to exit to normal operation.

Adjusting the Date and Clock

If the time stamp of the saved file is not correct, adjust the date and time by the following operation.

Adjusting the Date

1. Press the [FUNC] key.
2. Select [EXTENSION SETTING] → [DATE&TIME].
3. Select the item "DAY", "MONTH" or "YEAR".
4. Rotate the [MULTI] knob to select the "day", "month" and "year", then press the [MULTI] knob.
5. Press the [FUNC] key to save the new setting and exit the Setting Menu.
6. Press the [FUNC] key to exit to normal operation.

Adjusting the Clock

1. Press the [FUNC] key.
2. Select [EXTENSION SETTING] → [DATE&TIME].
3. Select the item "HOUR" or "MINUTE".
4. Rotate the [MULTI] knob to select the "hour" and "minute", then press the [MULTI] knob.
5. Press the [FUNC] key to save the new setting and exit the Setting Menu.
6. Press the [FUNC] key to exit to normal operation.

• Saving Memory data and Setting Menu data

The Memory Channel data, and the Setting Menu data can be saved to the SD Card:

1. Press the [FUNC] key.
2. Select [EXTENSION SETTING] → [SD CARD].
3. Touch "DONE" for the data item to be saved.
7. Touch the screen to end saving data.
8. Press the [FUNC] key twice to return to the normal operation screen.

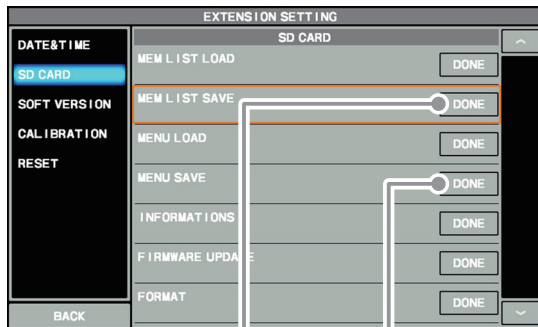

Saving memory data

Save setting menu data

4. To save the file with a new name, touch "NEW".



To overwrite previously saved data, touch the file name, and touch "OK" when the overwrite confirmation screen appears.

Touch "CANCEL" to cancel overwrite save.

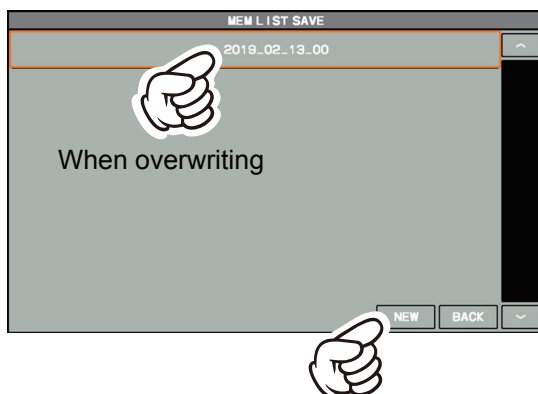

When saving with a new file name

Enter the file name (maximum 15 characters) on the file name input screen.

If the file name is not to be changed, proceed to step 6 as it is.



5. Touch "ENT" to start saving data, or touch "BACK" to cancel the name input.
6. "FILE SAVED" is displayed when data saving is completed.

• Reading Memory and Set Menu data

The Memory and Setting Menu data saved on the SD card may be read to the Transceiver.

1. Press the [FUNC] key.
2. Select [EXTENSION SETTING] → [SD CARD].
3. Touch “DONE” of the data item to be read.

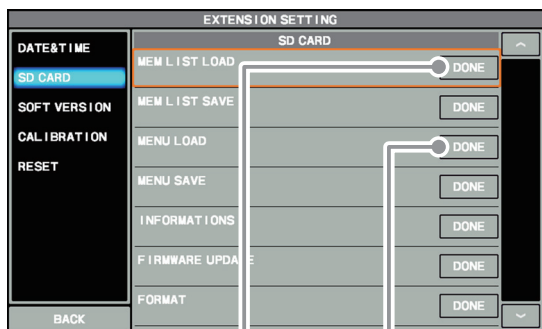

Reading memory data

Loading setting menu data

4. Touch the file name to be loaded.
Touch “BACK” to cancel reading data.

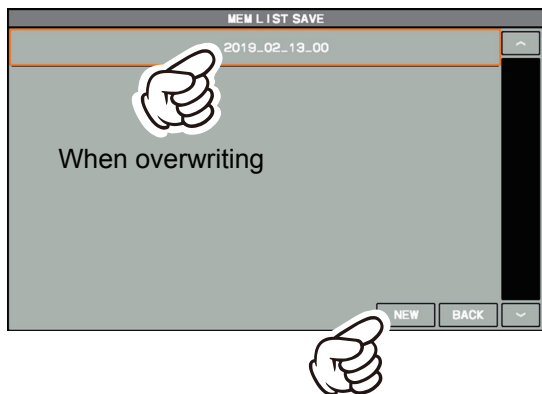

When saving with a new file name

5. When the overwrite confirmation screen appears, touch “OK”.
6. “FILE LOADED” is displayed when the data reading is completed.
7. Touch the TFT screen to finish loading the data.
8. Press the [FUNC] key twice to return to the normal operation screen.
9. Touch the screen to finish loading the data.
10. Once the power is turned OFF, the power is turned ON automatically afterwards.
With this, the Reading of data is completed.

• Display the SD Card Information

The memory free space of the SD card may be checked:

1. Press the [FUNC] key.
2. Select [EXTENSION SETTING] → [SD CARD].
3. Touch “DONE” of the “INFORMATIONS” item.
The capacity and free space of the SD card are displayed.



4. Touch “BACK” to return to the Setting Menu screen.
5. Press the [FUNC] key twice to return to the normal operation screen.

Setting Menu

The Menu system of the FTDX101 series provides extensive customization capability. The transceiver functions can be tailored for the most demanding operators. The Setting Menus are grouped into five specific utilization categories.

Comprehensive settings such as: Transmit & Receive, Interference Reduction, Memory, Scan, etc.

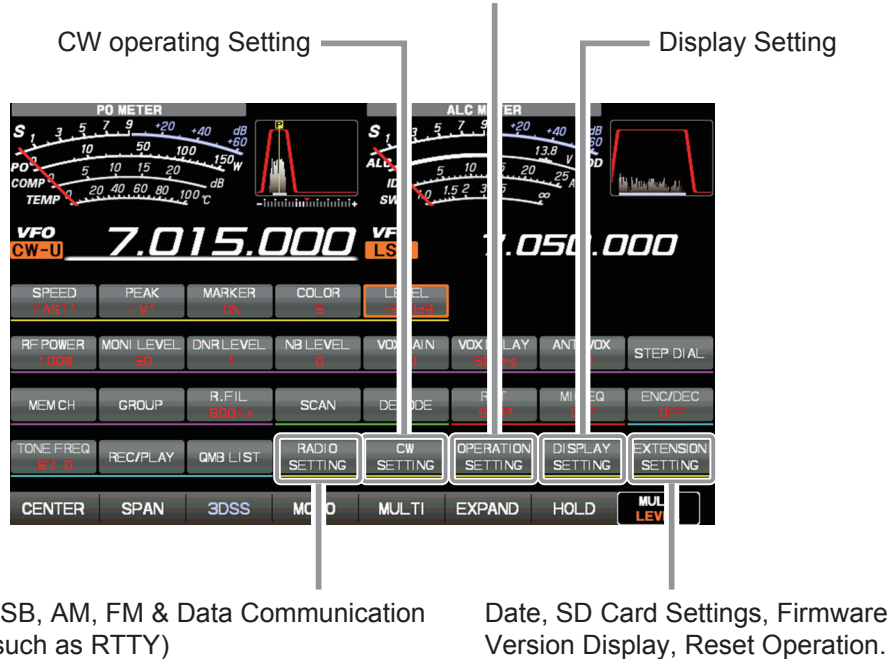

Using the Menu

1. Press the [FUNC] key.
2. Touch the category item that is to be set (see above).
3. Touch the desired item.
4. Touch the item setting that is to be changed.
5. Touch the desired setting, or turn the [MULTI] knob to change the setting.
6. Press the [FUNC] key to save the new setting and exit the Setting Menu.
7. Press the [FUNC] key to exit to normal operation.

Reset the Setting Menu

Use this procedure to restore the Menu settings to their factory defaults, without affecting the Programmed Frequency Memories.

1. Press the [FUNC] key.
2. Select [EXTENSION SETTING] → [RESET] .
3. Touch "DONE" of the "MENU CLEAR" item.
The reset confirmation screen will be displayed.
4. Touch "OK" or press the [MULTI] knob to reset.
(Touch "CANCEL" to cancel the reset)
5. Once the power is turned OFF, it will turn ON automatically afterwards.
Setting Menu reset is complete.

Menu Function		Available Settings (Default: Bold)
RADIO SETTING		
MODE SSB	AGC FAST DELAY	20 - 300 - 4000 (20msec/step)
	AGC MID DELAY	20 - 1000 - 4000 (20msec/step)
	AGC SLOW DELAY	20 - 3000 - 4000 (20msec/step)
	LCUT FREQ	OFF/ 100 - 1000 (50Hz/step)
	LCUT SLOPE	6dB/oct / 18dB/oct
	HCUT FREQ	700 - 3000 - 4000 (50Hz/step) / OFF
	HCUT SLOPE	6dB/oct / 18dB/oct
	SSB OUT SELECT	MAIN /SUB
	SSB OUT LEVEL	0 - 50 - 100
	TX BPF SEL	50-3050 / 100-2900 / 200-2800 / 300-2700 / 400-2600
	SSB MOD SOURCE	MIC / REAR
	REAR SELECT	DATA / USB
	RPORT GAIN	0 - 50 - 100
	RPTT SELECT	DAKY / RTS / DTR
MODE AM	AGC FAST DELAY	20 - 1000 - 4000 (20msec/step)
	AGC MID DELAY	20 - 2000 - 4000 (20msec/step)
	AGC SLOW DELAY	20 - 4000 (20msec/step)
	LCUT FREQ	OFF /100 - 1000 (50Hz/step)
	LCUT SLOPE	6dB/oct / 18dB/oct
	HCUT FREQ	700 - 4000 (50Hz/step)/ OFF
	HCUT SLOPE	6dB/oct / 18dB/oct
	AM OUT SELECT	MAIN / SUB
	AM OUT LEVEL	0 - 50 - 100
	TX BPF SEL	50-3050 / 100-2900 / 200-2800 / 300-2700 / 400-2600
	AM MOD SOURCE	MIC / REAR
	MIC GAIN	MCVR / 0 - 100
	REAR SELECT	DATA / USB
	RPORT GAIN	0 - 50 - 100
	RPTT SELECT	DAKY / RTS/DTR
MODE FM	AGC FAST DELAY	20 - 160 - 4000 (20msec/step)
	AGC MID DELAY	20 - 500 - 4000 (20msec/step)
	AGC SLOW DELAY	20 - 1500 - 4000 (20msec/step)
	LCUT FREQ	OFF / 100 - 300 - 1000 (50Hz/step)
	LCUT SLOPE	6dB/oct / 18dB/oct
	HCUT FREQ	700 - 3000 - 4000 (50Hz/step) / OFF
	HCUT SLOPE	6dB/oct / 18dB/oct
	FM OUT SELECT	MAIN / SUB
	FM OUT LEVEL	0 - 50 - 100
	FM MOD SOURCE	MIC / REAR
	MIC GAIN	MCVR / 0 - 100
	REAR SELECT	DATA / USB
	RPORT GAIN	0 - 50 - 100
	RPTT SELECT	DAKY / RTS/DTR
	RPT SHIFT(28MHz)	0 - 100 - 1000 (10kHz/step)
	RPT SHIFT(50MHz)	0 - 1000 - 4000 (10kHz/step)
MODE PSK/DATA	AGC FAST DELAY	20 - 160 - 4000 (20msec/step)
	AGC MID DELAY	20 - 500 - 4000 (20msec/step)
	AGC SLOW DELAY	20 - 1500 - 4000 (20msec/step)
	PSK TONE	1000 / 1500 / 2000 (Hz)
	DATA SHIFT (SSB)	0 - 1500 - 3000 (10Hz/step)
	LCUT FREQ	OFF / 100 - 300 - 1000 (50Hz/step)
	LCUT SLOPE	6dB/oct / 18dB/oct
	HCUT FREQ	700 - 3000 - 4000 (50Hz/step)/OFF
	HCUT SLOPE	6dB/oct / 18dB/oct

Menu Function		Available Settings (Default: Bold)
	DATA OUT SELECT	MAIN / SUB
	DATA OUT LEVEL	0 - 50 - 100
	TX BPF SEL	50-3050 / 100-2900 / 200-2800 / 300-2700 / 400-2600
	DATA MOD SOURCE	MIC / REAR
	REAR SELECT	DATA / USB
	RPORT GAIN	0 - 50 - 100
	RPTT SELECT	DAKY / RTS/DTR
MODE RTTY	AGC FAST DELAY	20 - 160 - 4000 (20msec/step)
	AGC MID DELAY	20 - 500 - 4000 (20msec/step)
	AGC SLOW DELAY	20 - 1500 - 4000 (20msec/step)
	POLARITY RX	NOR / REV
	POLARITY TX	NOR / REV
	LCUT FREQ	OFF / 100Hz - 300Hz - 1000Hz (50Hz/step)
	LCUT SLOPE	6dB/oct / 18dB/oct
	HCUT FREQ	700Hz - 3000Hz - 4000Hz (50Hz/step)/ OFF
	HCUT SLOPE	6dB/oct / 18dB/oct
	RTTY OUT SELECT	MAIN / SUB
	RTTY OUT LEVEL	0 - 50 - 100
	RPTT SELECT	DAKY / DTR / RTS
	MARK FREQUENCY	1275 / 2125 (Hz)
	SHIFT FREQUENCY	170 / 200 / 425 / 850 (Hz)
ENCDEC PSK	PSK MODE	BPSK / QPSK
	DECODE AFC RANGE	8 / 15 / 30 (Hz)
	QPSK POLARITY RX	NOR / REV
	QPSK POLARITY TX	NOR / REV
	PSK TX LEVEL	0 - 70 - 100
ENCDEC RTTY	RX USOS	OFF / ON
	TX USOS	OFF / ON
	RX NEW LINE CODE	CR, LF, CR+LF / CR+LF
	TX AUTO CR+LF	OFF / ON
	TX DIDDLE	OFF / BLANK / LTRS
	BAUDOT CODE	CCITT / US
CW SETTING		
MODE CW	AGC FAST DELAY	20 - 160 - 4000 (20msec/step)
	AGC MID DELAY	20 - 500 - 4000 (20msec/step)
	AGC SLOW DELAY	20 - 1500 - 4000 (20msec/step)
	LCUT FREQ	OFF / 100Hz - 250Hz - 1000Hz (50Hz/step)
	LCUT SLOPE	6dB/oct / 18dB/oct
	HCUT FREQ	700Hz - 1200Hz - 4000Hz (50Hz/step)/OFF
	HCUT SLOPE	6dB/oct / 18dB/oct
	CW OUT SELECT	MAIN / SUB
	CW OUT LEVEL	0 - 50 - 100
	CW AUTO MODE	OFF / 50M / ON
	CW BK-IN TYPE	SEMI / FULL
	CW BK-IN DELAY	30 - 200 - 3000 (msec)
	CW WAVE SHAPE	1 / 2 / 4 / 6 (msec)
	CW FREQ DISPLAY	DIRECT FREQ / PITCH OFFSET
	PC KEYING	OFF / DAKY / RTS / DTR
	QSK DELAY TIME	15 / 20 / 25 / 30 (msec)
	CW INDICATOR	OFF / ON
KEYER	F KEYER TYPE	OFF / BUG / ELEKEY-A / ELEKEY-B / ELEKEY-Y / ACS
	F KEYER DOT/DASH	NOR / REV
	R KEYER TYPE	OFF / BUG / ELEKEY-A / ELEKEY-B / ELEKEY-Y / ACS
	R KEYER DOT/DASH	NOR / REV
	CW WEIGHT	2.5 - 3.0 - 4.5

Menu Function		Available Settings (Default: Bold)
	NUMBER STYLE	1290 / AUNO / AUNT / A2NO / A2NT / 12NO / 12NT
	CONTEST NUMBER	1 - 999
	CW MEMORY 1	TEXT / MESSAGE
	CW MEMORY 2	TEXT / MESSAGE
	CW MEMORY 3	TEXT / MESSAGE
	CW MEMORY 4	TEXT / MESSAGE
	CW MEMORY 5	TEXT / MESSAGE
	REPEAT INTERVAL	1 - 5 - 60 (sec)
DECODE CW	CW DECODE BW	25 / 50 / 100 / 250 (Hz)
OPERATION SETTING		
GENERAL	DECODE RX SELECT	MAIN / SUB
	HEADPHONE MIX	SEPARATE / COMBINE-1 / COMBINE-2
	ANT3 SELECT	TRX / R3-T1 / R3-T2 / RX-ANT
	NB WIDTH	1 / 3 / 10 (msec)
	NB REJECTION	10 / 30 / 40 (dB)
	BEEP LEVEL	0 - 10 - 100
	RF/SQL VR	RF / SQL
	TUNER SELECT	INT / EXT1/EXT2/EXT3
	232C RATE	4800 / 9600 / 19200 / 38400 (bps)
	232C TIME OUT TIMER	10 / 100 / 1000 / 3000 (msec)
	CAT RATE	4800 / 9600 / 19200 / 38400 (bps)
	CAT TIME OUT TIMER	10 / 100 / 1000 / 3000 (msec)
	CAT RTS	OFF / ON
	QMB CH	5ch / 10ch
	MEM GROUP	OFF / ON
	QUICK SPLIT INPUT	OFF / ON
	QUICK SPLIT FREQ	-20 - 5 - 20 (kHz)
	TX TIME OUT TIMER	OFF / 1 - 30 (min)
	MIC SCAN	OFF / ON
	MIC SCAN RESUME	PAUSE / TIME
	REF FREQ FINE ADJ	-25 - 0 - 25
	CS DIAL	RF POWER / MONI LEVEL / DNR LEVEL / NB LEVEL / VOX GAIN / VOX DELAY / ANTI VOX / STEP DIAL / MEM CH / GROUP / R.FIL
	KEYBOARD LANGUAGE	JAPANESE / ENGLISH(US) / ENGLISH(UK) / FRENCH / FRENCH(CA) / GERMAN / PORTUGUESE / PORTUGUESE(BR) / SPANISH / SPANISH(LATAM) / ITALIAN
RX DSP	APF WIDTH	NARROW / MEDIUM / WIDE
	CONTOUR LEVEL	-40 - -15 - 0 - 20
	CONTOUR WIDTH	1 - 10 - 11
	DNR LEVEL	1 - 15
	IF NOTCH WIDTH	NARROW / WIDE
TX AUDIO	PROC LEVEL	COMP / AMC
	AMC RELEASE TIME	FAST / MID / SLOW
	PRMTRC EQ1 FREQ	OFF / 100 - 700 (100Hz/step)
	PRMTRC EQ1 LEVEL	-10 - 0 - 5 - 10
	PRMTRC EQ1 BWTH	0 - 10
	PRMTRC EQ2 FREQ	OFF / 700 - 1500 (100Hz/step)
	PRMTRC EQ2 LEVEL	-10 - 0 - 5 - 10
	PRMTRC EQ2 BWTH	0 - 10
	PRMTRC EQ3 FREQ	OFF / 1500 - 3200 (100Hz/step)
	PRMTRC EQ3 LEVEL	-10 - 0 - 5 - 10
	PRMTRC EQ3 BWTH	0 - 10
	P PRMTRC EQ1 FREQ	OFF / 100 - 700 (100Hz/step)

Menu Function		Available Settings (Default: Bold)
	P PRMTRC EQ1 LEVEL	-10 - 0 - 10
	P PRMTRC EQ1 BWTH	0 - 2 - 10
	P PRMTRC EQ2 FREQ	OFF / 700 - 1500 (100Hz/step)
	P PRMTRC EQ2 LEVEL	-10 - 0 - 10
	P PRMTRC EQ2 BWTH	0 - 1 - 10
	P PRMTRC EQ3 FREQ	OFF / 1500 - 3200 (100Hz/step)
	P PRMTRC EQ3 LEVEL	-10 - 0 - 10
	P PRMTRC EQ3 BWTH	0 - 1 - 10
TX GENERAL	HF MAX POWER	5 - 200 (W) (FTDX101D is 5 - 100W)
	50M MAX POWER	5 - 200 (W) (FTDX101D is 5 - 100W)
	70M MAX POWER	5 - 50 (W)
	AM MAX POWER	5 - 50 (W) (FTDX101D is 5 - 25W)
	VOX SELECT	MIC / DATA
	DATA VOX GAIN	0 - 50 - 100
	EMERGENCY FREQ TX	OFF / ON
TUNING	SSB/CW DIAL STEP	5 / 10 (Hz)
	RTTY/PSK DIAL STEP	5 / 10 (Hz)
	CH STEP	1 / 2.5 / 5 (kHz)
	AM CH STEP	2.5 / 5 / 9 / 10 / 12.5 / 25 (kHz)
	FM CH STEP	5 / 6.25 / 10 / 12.5 / 20 / 25 (kHz)
	MAIN STEPS PER REV.	250 / 500 / 1000
	MPVD STEPS PER REV.	250 / 500
DISPLAY SETTING		
DISPLAY	MY CALL	Max 12 characters (FTDX101)
	MY CALL TIME	OFF / 1 / 2 / 3 / 4 / 5 (sec)
	SCREEN SAVER	OFF / 15 / 30 / 60 (min)
	TFT CONTRAST	0 - 10 - 20
	TFT DIMMER	0 - 15 - 20
	LED DIMMER	0 - 10 - 20
	MOUSE POINTER SPEED	0 - 10 - 20
	FREQ STYLE	LIGHT / BOLD
SCOPE	RBW	HIGH / MID / LOW
	SCOPE CTR	FILTER / CAR POINT
	2D DISP SENSITIVITY	NORMAL / HI
	3DSS DISP SENSITIVITY	NORMAL / HI
EXT MONITOR	EXT DISPLAY	OFF / ON
	PIXEL	800x480 / 800x600
EXTENSION SETTING		
DATE&TIME	DAY	-
	MONTH	-
	YEAR	-
	HOUR	-
	MINUTE	-
SD CARD	MEM LIST LOAD	-
	MEM LIST SAVE	-
	MENU LOAD	-
	MENU SAVE	-
	INFORMATIONS	-
	FIRMWARE UPDATE	-
	FORMAT	-
SOFT VERSION		-
CALIBRATION	CALIBRATION	-
RESET	MEMORY CLEAR	-
	MENU CLEAR	-
	ALL RESET	-

RADIO SETTING - MODE SSB -

AGC FAST DELAY

Function: Sets the AGC-FAST DELAY voltage decay characteristics for SSB mode.

Available Values: 20 - 4000msec

Default Setting: 300msec

Description: Sets the AGC voltage decay characteristics in 20 msec steps after the input signal level becomes lower than the AGC detection level and the HOLD time has expired.

AGC MID DELAY

Function: Sets the AGC-MID DELAY voltage decay characteristics for SSB mode.

Available Values: 20 - 4000msec

Default Setting: 1000msec

Description: Sets the AGC voltage decay characteristics in 20 msec steps after the input signal level becomes lower than the AGC detection level and the HOLD time has expired.

AGC SLOW DELAY

Function: Sets the AGC-SLOW DELAY voltage decay characteristics for SSB mode.

Available Values: 20 - 4000msec

Default Setting: 3000msec

Description: Sets the AGC voltage decay characteristics in 20 msec steps after the input signal level becomes lower than the AGC detection level and the HOLD time has expired.

LCUT FREQ

Function: Sets the low-frequency cutoff audio filter in SSB mode.

Available Values: OFF / 100Hz - 1000Hz

Default Setting: 100Hz

Description: The cutoff frequency can be set at 50 Hz increments between 100 Hz and 1000 Hz.

LCUT SLOPE

Function: Sets the slope of the low-frequency cutoff audio filter in SSB mode.

Available Values: 6dB/oct / 18dB/oct

Default Setting: 6dB/oct

HCUT FREQ

Function: Sets the high-frequency cutoff audio filter in SSB mode.

Available Values: 700Hz - 4000Hz / OFF

Default Setting: 3000Hz

Description: The cutoff frequency can be set at 50 Hz increments between 700 Hz and 4000 Hz.

HCUT SLOPE

Function: Sets the slope of the high-frequency cutoff audio filter in SSB mode.

Available Values: 6dB/oct / 18dB/oct

Default Setting: 6dB/oct

SSB OUT SELECT

Function: SSB signal output band setting from RTTY/DATA jack.

Available Values: MAIN / SUB

Default Setting: MAIN

Description: Select the band to output the SSB signal.

SSB OUT LEVEL

Function: Sets the level of the receive SSB signal output from the RTTY/DATA jack.

Available Values: 0 - 100

Default Setting: 50

TX BPF SEL

Function: Selects the audio passband of the DSP modulator on the SSB mode.

Available Values: 50-3050 / 100-2900 / 200-2800 / 300-2700 / 400-2600 (Hz)

Default Setting: 300-2700 Hz

SSB MOD SOURCE

Function: Selects the microphone input jack for SSB mode.

Available Values: MIC / REAR

Default Setting: MIC

Description:

MIC: Audio is input from the MIC jack on the front panel.

REAR: Disables the microphone circuit on the front panel and inputs audio/data from the USB jack or RTTY/DATA jack on the rear panel.

REAR SELECT

Function: Selects the input jack of the SSB signal.

Available Values: DATA / USB

Default Setting: DATA

Description: Selects the input jack of the SSB signal when "SSB MOD SOURCE" is set to "REAR".

DATA: Inputs from the RTTY/DATA jack on the rear panel.

USB: Inputs from the USB jack on the rear panel.

RPORT GAIN

Function: Sets the level of the SSB signal input when "SSB MOD SOURCE" is set to "REAR".

Available Values: 0 - 100

Default Setting: 50

RPTT SELECT

Function: Sets the PTT control for the SSB transmit signal.

Available Values: DAKY / RTS / DTR

Default Setting: DAKY

Description:

DAKY: Controls the SSB transmit signal from the RTTY/DATA jack (pin 3) on the rear panel.

DTR: Controls the SSB transmit signal from the USB virtual COM/DTR ports.

RTS: Controls the SSB transmit signal from the USB virtual COM/RTS ports.

RADIO SETTING - MODE AM -

AGC FAST DELAY

Function: Sets the AGC-FAST DELAY voltage decay characteristics for AM mode.

Available Values: 20 - 4000msec

Default Setting: 1000msec

Description: Sets the AGC voltage decay characteristics in 20 msec steps after the input signal level becomes lower than the AGC detection level and the HOLD time has expired.

AGC MID DELAY

Function: Sets the AGC-MID DELAY voltage decay characteristics for AM mode.

Available Values: 20 - 4000msec

Default Setting: 2000msec

Description: Sets the AGC voltage decay characteristics in 20 msec steps after the input signal level becomes lower than the AGC detection level and the HOLD time has expired.

AGC SLOW DELAY

Function: Sets the AGC-SLOW DELAY voltage decay characteristics for AM mode.

Available Values: 20 - 4000msec

Default Setting: 4000msec

Description: Sets the AGC voltage decay characteristics in 20 msec steps after the input signal level becomes lower than the AGC detection level and the HOLD time has expired.

LCUT FREQ

Function: Sets the low-frequency cutoff audio filter in AM mode.

Available Values: OFF / 100Hz - 1000Hz

Default Setting: OFF

Description: The cutoff frequency can be set at 50 Hz increments between 100 Hz and 1000 Hz.

LCUT SLOPE

Function: Sets the slope of the low-frequency cutoff audio filter in AM mode.

Available Values: 6dB/oct / 18dB/oct

Default Setting: 6dB/oct

HCUT FREQ

Function: Sets the high-frequency cutoff audio filter in AM mode.

Available Values: 700Hz - 4000Hz / OFF

Default Setting: OFF

Description: The cutoff frequency can be set at 50 Hz increments between 700 Hz and 4000 Hz.

HCUT SLOPE

Function: Sets the slope of the high-frequency cutoff audio filter in AM mode.

Available Values: 6dB/oct / 18dB/oct

Default Setting: 6dB/oct

AM OUT SELECT

Function: AM signal output band setting from RTTY/DATA jack.

Available Values: MAIN / SUB

Default Setting: MAIN

Description: Select the band to output the AM signal.

AM OUT LEVEL

Function: Sets the level of the receive AM signal output from the RTTY/DATA jack.

Available Values: 0 - 100

Default Setting: 50

TX BPF SEL

Function: Selects the audio passband of the DSP modulator on the AM mode.

Available Values: 50-3050 / 100-2900 / 200-2800
300-2700 / 400-2600 (Hz)

Default Setting: 50-3050 Hz

AM MOD SOURCE

Function: Selects the microphone input jack for AM mode.

Available Values: MIC / REAR

Default Setting: MIC

Description:

MIC: Audio is input from the MIC jack on the front panel.

REAR: Disables the microphone circuit on the front panel and inputs audio/data from the USB jack or RTTY/DATA jack on the rear panel.

MIC GAIN

Function: Sets the microphone gain for the AM mode.

Available Values: MCVR / 0 - 100

Default Setting: MCVR

Description:

MCVR: Adjust the microphone gain (0 - 100) using the front panel [MIC/SPEED] knob.

0 - 100: Fixed to the set value.

REAR SELECT

Function: Selects the input jack of the AM signal.

Available Values: DATA / USB

Default Setting: DATA

Description: Selects the input jack of the AM signal when "AM MOD SOURCE" is set to "REAR".

DATA: Inputs from the RTTY/DATA jack on the rear panel.

USB: Inputs from the USB jack on the rear panel.

RPORT GAIN

Function: Sets the level of the AM signal input when "AM MOD SOURCE" is set to "REAR".

Available Values: 0 - 100

Default Setting: 50

RPTT SELECT

Function: Sets the PTT control for the AM transmit signal.

Available Values: DAKY / RTS / DTR

Default Setting: DAKY

Description:

DAKY: Controls the AM transmit signal from the RTTY/DATA jack (pin 3) on the rear panel.

DTR: Controls the AM transmit signal from the USB virtual COM/DTR ports.

RTS: Controls the AM transmit signal from the USB virtual COM/RTS ports.

RADIO SETTING - MODE FM -

AGC FAST DELAY

Function: Sets the AGC-FAST DELAY voltage decay characteristics for FM mode.

Available Values: 20 - 4000msec

Default Setting: 160msec

Description: Sets the AGC voltage decay characteristics in 20 msec steps after the input signal level becomes lower than the AGC detection level and the HOLD time has expired.

AGC MID DELAY

Function: Sets the AGC-MID DELAY voltage decay characteristics for FM mode.

Available Values: 20 - 4000msec

Default Setting: 500msec

Description: Sets the AGC voltage decay characteristics in 20 msec steps after the input signal level becomes lower than the AGC detection level and the HOLD time has expired.

AGC SLOW DELAY

Function: Sets the AGC-SLOW DELAY voltage decay characteristics for FM mode.

Available Values: 20 - 4000msec

Default Setting: 1500msec

Description: Sets the AGC voltage decay characteristics in 20 msec steps after the input signal level becomes lower than the AGC detection level and the HOLD time has expired.

LCUT FREQ

Function: Sets the low-frequency cutoff audio filter in FM mode.

Available Values: OFF / 100Hz - 1000Hz

Default Setting: 300

Description: The cutoff frequency can be set at 50 Hz increments between 100 Hz and 1000 Hz.

LCUT SLOPE

Function: Sets the slope of the low-frequency cutoff audio filter in FM mode.

Available Values: 6dB/oct / 18dB/oct

Default Setting: 18dB/oct

HCUT FREQ

Function: Sets the high-frequency cutoff audio filter in FM mode.

Available Values: 700Hz - 4000Hz/OFF

Default Setting: 3000Hz

Description: The cutoff frequency can be set at 50 Hz increments between 700 Hz and 4000 Hz.

HCUT SLOPE

Function: Sets the slope of the high-frequency cutoff audio filter in FM mode.

Available Values: 6dB/oct / 18dB/oct

Default Setting: 18dB/oct

FM OUT SELECT

Function: FM signal output band setting from RTTY/DATA jack.

Available Values: MAIN / SUB

Default Setting: MAIN

Description: Select the band to output the FM signal.

FM OUT LEVEL

Function: Sets the level of the receive FM signal output from the RTTY/DATA jack.

Available Values: 0 - 100

Default Setting: 50

FM MOD SOURCE

Function: Selects the microphone input jack for FM mode.

Available Values: MIC / REAR

Default Setting: MIC

Description:

MIC: Audio is input from the MIC jack on the front panel.

REAR: Disables the microphone circuit on the front panel and inputs audio/data from the USB jack or RTTY/DATA jack on the rear panel.

MIC GAIN

Function: Sets the microphone gain for the FM mode.

Available Values: MCVR / 0 - 100

Default Setting: MCVR

Description:

MCVR: Adjust the microphone gain (0 - 100) using the front panel [MIC/SPEED] knob.

0 - 100: Fixed to the set value.

REAR SELECT

Function: Selects the input jack of the FM signal.

Available Values: DATA / USB

Default Setting: DATA

Description: Selects the input jack of the FM signal when "FM MOD SOURCE" is set to "REAR".

DATA: Inputs from the RTTY/DATA jack on the rear panel.

USB: Inputs from the USB jack on the rear panel.

RPORT GAIN

Function: Sets the level of the FM signal input when "FM MOD SOURCE" is set to "REAR".

Available Values: 0 - 100

Default Setting: 50

RPTT SELECT

Function: Sets the PTT control for the FM transmit signal.

Available Values: DAKY / RTS / DTR

Default Setting: DAKY

Description:

DAKY: Controls the FM transmit signal from the RTTY/DATA jack (pin 3) on the rear panel.

DTR: Controls the FM transmit signal from the USB virtual COM/DTR ports.

RTS: Controls the FM transmit signal from the USB virtual COM/RTS ports.

RPT SHIFT(28MHz)

Function: Sets the RPT offset frequency on the 28 MHz band.

Available Values: 0 - 1000 kHz

Default Setting: 100 kHz

Description: The RPT offset frequency can be set at 10 kHz increments between 0 kHz and 1000 kHz.

RPT SHIFT(50MHz)

Function: Sets the RPT offset frequency on the 50 MHz band.

Available Values: 0 - 4000 kHz

Default Setting: 1000kHz

Description: The RPT offset frequency can be set at 10 kHz increments between 0 kHz and 4000 kHz.

RADIO SETTING - MODE PSK/DATA -

AGC FAST DELAY

Function: Sets the AGC-FAST DELAY voltage decay characteristics for PSK/DATA mode.

Available Values: 20 - 4000msec

Default Setting: 160msec

Description: Sets the AGC voltage decay characteristics in 20 msec steps after the input signal level becomes lower than the AGC detection level and the HOLD time has expired.

AGC MID DELAY

Function: Sets the AGC-MID DELAY voltage decay characteristics for PSK/DATA mode.

Available Values: 20 - 4000msec

Default Setting: 500msec

Description: Sets the AGC voltage decay characteristics in 20 msec steps after the input signal level becomes lower than the AGC detection level and the HOLD time has expired.

AGC SLOW DELAY

Function: Sets the AGC-SLOW DELAY voltage decay characteristics for PSK/DATA mode.

Available Values: 20 - 4000msec

Default Setting: 1500msec

Description: Sets the AGC voltage decay characteristics in 20 msec steps after the input signal level becomes lower than the AGC detection level and the HOLD time has expired.

PSK TONE

Function: Set the PSK tone

Available Values: 1000 / 1500 / 2000 Hz

Default Setting: 1000 Hz

DATA SHIFT (SSB)

Function: Sets the carrier point in DATA mode.

Available Values: 0 - 3000 Hz

Default Setting: 1500 Hz

Description: The frequency can be set in steps of 10 Hz.

LCUT FREQ

Function: Sets the low-frequency cutoff audio filter in DATA mode.

Available Values: OFF / 100Hz - 1000Hz

Default Setting: 300

Description: The cutoff frequency can be set at 50 Hz increments between 100 Hz and 1000 Hz.

LCUT SLOPE

Function: Sets the slope of the low-frequency cutoff audio filter in DATA mode.

Available Values: 6dB/oct / 18dB/oct

Default Setting: 18dB/oct

HCUT FREQ

Function: Sets the high-frequency cutoff audio filter in DATA mode.

Available Values: 700Hz - 4000Hz / OFF

Default Setting: 3000Hz

Description: The cutoff frequency can be set at 50 Hz increments between 700 Hz and 4000 Hz.

HCUT SLOPE

Function: Sets the slope of the high-frequency cutoff audio filter in DATA mode.

Available Values: 6dB/oct / 18dB/oct

Default Setting: 18dB/oct

DATA OUT SELECT

Function: DATA signal output band setting from RTTY/DATA jack.

Available Values: MAIN / SUB

Default Setting: MAIN

Description: Select the band to output the DATA signal.

DATA OUT LEVEL

Function: Sets the level of the receive DATA signal output from the RTTY/DATA jack.

Available Values: 0 - 100

Default Setting: 50

TX BPF SEL

Function: Selects the audio passband of the DSP modulator on the DATA mode.

Available Values: 50-3050 / 100-2900 / 200-2800
300-2700 / 400-2600 (Hz)

Default Setting: 300-27000 Hz

DATA MOD SOURCE

Function: Selects the microphone input jack for DATA mode.

Available Values: MIC / REAR

Default Setting: REAR

Description:

MIC: Audio is input from the MIC jack on the front panel.

REAR: Disables the microphone circuit on the front panel and inputs audio/data from the USB jack or RTTY/DATA jack on the rear panel.

REAR SELECT

Function: Selects the input jack of the DATA signal.

Available Values: DATA / USB

Default Setting: DATA

Description: Selects the input jack of the AM signal when "DATA MOD SOURCE" is set to "REAR".

DATA: Is input to the RTTY/DATA jack on the rear panel.

USB: Is input the USB jack on the rear panel.

RPORT GAIN

Function: Sets the level of the DATA signal input when "DATA MOD SOURCE" is set to "REAR".

Available Values: 0 - 100

Default Setting: 50

RPTT SELECT

Function: Sets the PTT control for the DATA transmit signal.

Available Values: DAKY / RTS / DTR

Default Setting: DAKY

Description:

DAKY: Controls the DATA transmit signal from the RTTY/DATA jack (pin 3) on the rear panel.

DTR: Controls the DATA transmit signal from the USB virtual COM/DTR ports.

RTS: Controls the DATA transmit signal from the USB virtual COM/RTS ports.

RADIO SETTING - MODE RTTY -

AGC FAST DELAY

Function: Sets the AGC-FAST DELAY voltage decay characteristics for RTTY mode.

Available Values: 20 - 4000msec

Default Setting: 160msec

Description: Sets the AGC voltage decay characteristics in 20 msec steps after the input signal level becomes lower than the AGC detection level and the HOLD time has expired.

AGC MID DELAY

Function: Sets the AGC-MID DELAY voltage decay characteristics for RTTY mode.

Available Values: 20 - 4000msec

Default Setting: 500msec

Description: Sets the AGC voltage decay characteristics in 20 msec steps after the input signal level becomes lower than the AGC detection level and the HOLD time has expired.

AGC SLOW DELAY

Function: Sets the AGC-SLOW DELAY voltage decay characteristics for RTTY mode.

Available Values: 20 - 4000msec

Default Setting: 1500msec

Description: Sets the AGC voltage decay characteristics in 20 msec steps after the input signal level becomes lower than the AGC detection level and the HOLD time has expired.

POLARITY RX

Function: Sets the shift direction for receiving in RTTY mode.

Available Values: NOR / REV

Default Setting: NOR

Description:

NOR: The space frequency will be lower than the mark frequency.

REV: The mark frequency will be lower than the space frequency.

POLARITY TX

Function: Sets the shift direction for transmitting in RTTY mode.

Available Values: NOR / REV

Default Setting: NOR

Description:

NOR: The space frequency will be lower than the mark frequency.

REV: The mark frequency will be lower than the space frequency.

LCUT FREQ

Function: Sets the low-frequency cutoff audio filter in RTTY mode.

Available Values: OFF / 100Hz - 1000Hz

Default Setting: 300Hz

Description: The cutoff frequency can be set at 50 Hz increments between 100 Hz and 1000 Hz.

LCUT SLOPE

Function: Sets the slope of the low-frequency cutoff audio filter in RTTY mode.

Available Values: 6dB/oct / 18dB/oct

Default Setting: 18dB/oct

HCUT FREQ

Function: Sets the high-frequency cutoff audio filter in RTTY mode.

Available Values: 700Hz - 4000Hz / OFF

Default Setting: 3000Hz

Description: The cutoff frequency can be set at 50 Hz increments between 700 Hz and 4000 Hz.

HCUT SLOPE

Function: Sets the slope of the high-frequency cutoff audio filter in RTTY mode.

Available Values: 6dB/oct / 18dB/oct

Default Setting: 18dB/oct

RTTY OUT SELECT

Function: RTTY signal output band setting from RTTY/DATA jack.

Available Values: MAIN / SUB

Default Setting: MAIN

Description: Select the band to output the RTTY signal.

RTTY OUT LEVEL

Function: Sets the level of the receive RTTY signal output from the RTTY/DATA jack.

Available Values: 0 - 100

Default Setting: 50

RPTT SELECT

Function: Sets the PTT control for the RTTY transmit signal.

Available Values: DAKY / RTS / DTR

Default Setting: DAKY

Description:

DAKY: Controls the RTTY transmit signal from the RTTY/DATA jack (pin 3) on the rear panel.

DTR: Controls the RTTY transmit signal from the USB virtual COM/DTR ports.

RTS: Controls the RTTY transmit signal from the USB virtual COM/RTS ports.

MARK FREQUENCY

Function: Sets the mark frequency for RTTY mode.

Available Values: 1275 / 2125 (Hz)

Default Setting: 2125Hz

SHIFT FREQUENCY

Function: Sets the shift width for RTTY mode.

Available Values: 170 / 200 / 425 / 850 (Hz)

Default Setting: 170Hz

RADIO SETTING - ENCDEC PSK -

PSK MODE

Function: Selects the operation mode of the PSK mode.

Available Values: BPSK / QPSK

Default Setting: BPSK

Description:

BPSK: This is a standard mode. Normally use this mode.

QPSK: This is a mode with error correction function.

DECODE AFC RANGE

Function: Selects the operation range (or bandwidth) of the AFC feature.

Available Values: 8 / 15 / 30 (Hz)

Default Setting: 15 Hz

Description: Automatically tunes to the PSK signal within the set range for the display frequency.

QPSK POLARITY RX

Function: Setting QPSK Decode Phase Shift Direction.

Available Values: NOR / REV

Default Setting: NOR

Description: Sets the phase shift direction during QPSK reception.

NOR: Normally use this mode.

REV: Inverts the phase of decoding.

QPSK POLARITY TX

Function: Setting QPSK Encode Phase Shift Direction.

Available Values: NOR / REV

Default Setting: NOR

Description: Sets the phase shift direction for QPSK transmission.

NOR: Normally use this mode.

REV: Inverts the phase of encoding.

PSK TX LEVEL

Function: Data output level setting during PSK communication

Available Values: 0 - 100

Default Setting: 70

RADIO SETTING - ENCDEC RTTY -

RX USOS

Function: Enables/Disables the RX USOS feature.

Available Values: OFF / ON

Default Setting: ON

Description: When the space symbol is received, the RX USOS function that automatically switches to character reception (LTRS) is turned ON or OFF.

TX USOS

Function: Enables/Disables the TX USOS feature.

Available Values: OFF / ON

Default Setting: ON

Description: When sending a number and a symbol following a space symbol, the TX USOS function to forcibly insert the FIGS code is turned ON or OFF.

RX NEW LINE CODE

Function: Selects the command code used for the Carriage Return during RTTY receive.

Available Values: CR, LF, CR+LF / CR+LF

Default Setting: CR, LF, CR+LF

Description: Set the code to perform line feed for RTTY.

CR, LF, CR+LF: Do a line break with all codes.

CR+LF: Line feed is performed only for CR + LF code.

TX AUTO CR+LF

Function: Enables/Disables the sending of the Carriage Return (CR+LF) Code while transmitting in RTTY.

Available Values: OFF / ON

Default Setting: ON

TX DIDDLE

Function: Selects the transmission code when there is not a character to be transmitted.

Available Values: OFF / BLANK / LTRS

Default Setting: BLANK

Description: This code is sent when there are no characters sending.

BLANK: If there is no character transmission, a blank code is transmitted.

LTRS: When there are no characters transmitted, the letter code is transmitted.

OFF: Does not send out the code.

BAUDOT CODE

Function: Selects the Baudot Code used for the RTTY mode.

Available Values: CCITT / US

Default Setting: US

CW SETTING - MODE CW -

AGC FAST DELAY

Function: Sets the AGC-FAST DELAY voltage decay characteristics for CW mode.

Available Values: 20 - 4000msec

Default Setting: 160msec

Description: Sets the AGC voltage decay characteristics in 20 msec steps after the input signal level becomes lower than the AGC detection level and the HOLD time has expired.

AGC MID DELAY

Function: Sets the AGC-MID DELAY voltage decay characteristics for CW mode.

Available Values: 20 - 4000msec

Default Setting: 500msec

Description: Sets the AGC voltage decay characteristics in 20 msec steps after the input signal level becomes lower than the AGC detection level and the HOLD time has expired.

AGC SLOW DELAY

Function: Sets the AGC-SLOW DELAY voltage decay characteristics for CW mode.

Available Values: 20 - 4000msec

Default Setting: 1500msec

Description: Sets the AGC voltage decay characteristics in 20 msec steps after the input signal level becomes lower than the AGC detection level and the HOLD time has expired.

LCUT FREQ

Function: Sets the low-frequency cutoff audio filter in CW mode.

Available Values: OFF / 100Hz - 1000Hz

Default Setting: 250Hz

Description: The cutoff frequency can be set at 50 Hz increments between 100 Hz and 1000 Hz.

LCUT SLOPE

Function: Sets the slope of the low-frequency cutoff audio filter in CW mode.

Available Values: 6dB/oct / 18dB/oct

Default Setting: 18dB/oct

HCUT FREQ

Function: Sets the high-frequency cutoff audio filter in CW mode.

Available Values: 700Hz - 4000Hz / OFF

Default Setting: 1200Hz

Description: The cutoff frequency can be set at 50 Hz increments between 700 Hz and 4000 Hz.

HCUT SLOPE

Function: Sets the slope of the high-frequency cutoff audio filter in CW mode.

Available Values: 6dB/oct / 18dB/oct

Default Setting: 18dB/oct

CW OUT SELECT

Function: CW signal output band setting from RTTY/DATA jack.

Available Values: MAIN / SUB

Default Setting: MAIN

Description: Select the band to output the CW signal.

CW OUT LEVEL

Function: Sets the level of the CW signal output from the RTTY/DATA jack.

Available Values: 0 - 100

Default Setting: 50

CW AUTO MODE

Function: Enables/disables CW keying while operating on SSB.

Available Values: OFF / 50M (50MHz) / ON

Default Setting: OFF

Description:

OFF: Disables CW keying while operating on SSB.

50M: Enables CW keying while operating SSB on 50 MHz (but not HF).

ON: Enables CW keying while operating SSB on all TX bands.

CW BK-IN TYPE

Function: Sets the CW brake-in function.

Available Values: SEMI / FULL

Default Setting: SEMI

Description:

SEMI: A brief delay is provided after the CW keying operation, before the transceiver returns to receive mode.

The receiver recovery time may be changed using "CW BK-IN DELAY".

FULL: The transceiver immediately returns to receive mode after every CW key-up (QSK mode).

CW BK-IN DELAY

Function: Sets the CW delay time.

Available Values: 30msec - 3000msec

Default Setting: 200msec

Description: The delay time can be changed between 30 msec and 3000 msec.

CW WAVE SHAPE

Function: Selects the CW carrier wave-form shape (rise/fall times).

Available Values: 1ms / 2ms / 4ms / 6ms

Default Setting: 4ms (msec)

Description: Sets the rise and fall times of the keying envelope in CW mode (transmit waveform).

CW FREQ DISPLAY

Function: Sets the PITCH frequency offset.

Available Values: DIRECT FREQ / PITCH OFF-SET

Default Setting: PITCH OFFSET

Description: Sets the displayed frequency offset when switching the transceiver mode between SSB and CW.

DIRECT FREQ: Displays the same frequency in CW mode as in SSB mode without any offset added.

PITCH OFFSET: Displays the frequency in CW mode with the pitch offset added. When CW BFO is set to USB, the displayed frequency will be increased and when CW BFO is set to LSB, the displayed frequency will be decreased with pitch offset added.

PC KEYING

Function: Sets the RTTY/DATA jack for PC keying.

Available Values: OFF / DAKY / RTS / DTR

Default Setting: OFF

Description:

OFF: Disables PC keying from DATA PTT (pin 3) of the RTTY/DATA jack.

DAKY: Controls the transmit from the RTTY/DATA jack (pin 3) on the rear panel.

RTS: Controls the transmit from the USB virtual COM/RTS ports.

DTR: Controls the transmit from the USB virtual COM/DTR ports.

QSK DELAY TIME

Function: Sets the time delay before transmitting the keying signal.

Available Values: 15 / 20 / 25 / 30 msec

Default Setting: 15 msec

Description: The delay time in QSK mode before transmitting the CW signal may be set in 5 msec steps.

CW INDICATOR

Function: Bar display settings shown below the filter function display in CW mode.

Available Values: OFF / ON

Default Setting: ON

Description: In CW mode, the bar shown below the filter function display may be set to ON or OFF.

CW SETTING - KEYER -

F KEYER TYPE

Function: Selects the desired keyer operation mode for the device connected to the front panel KEY jack.

Available Values: OFF / BUG / ELEKEY-A/
ELEKEY-B / ELEKEY-Y / ACS

Default Setting: ELEKEY-B

Description:

OFF: Disables the keyer function.

BUG: Functions as a "BUG key". Only the "Dot" side is automatically generated (the "Dash" side is generated manually).

ELEKEY-A: A code element ("Dot" or "Dash" side) is transmitted upon pressing both sides of the paddle.

ELEKEY-B: Pressing both sides of the paddle transmits the currently generated "Dash" side followed by "Dot" side (or reverse order).

ELEKEY-Y: Pressing both sides of the paddle transmits the currently generated "Dash" side followed by "Dot" side (or reverse order).

While transmitting the "Dash" side, the first transmitted "Dot" side will not be stored.

ACS: Functions as the "Keyer with automatic spacing control feature" which sets spacing between characters precisely to be the same length as a dash (three dots in length).

F KEYER DOT/DASH

Function: Reverses the connections of the CW paddle front panel key jack.

Available Values: NOR / REV

Default Setting: NOR

Description:

NOR: Press the right side of the paddle to transmit the "Dot" signal and press the left side of the paddle to transmit the "Dash" signal.

REV: Press the left side of the paddle to transmit the "Dash" signal and press the right side of the paddle to transmit the "Dot" signal.

R KEYER TYPE

Function: Selects the desired keyer operation mode for the device connected to the rear panel KEY jack.

Available Values: OFF / BUG / ELEKEY-A / ELEKEY-B / ELEKEY-Y / ACS

Default Setting: ELEKEY-B

Description:

OFF: Disables the keyer function.

BUG: Functions as a "BUG key". Only the "Dot" side is automatically generated (the "Dash" side is generated manually).

ELEKEY-A: A code element ("Dot" or "Dash") is transmitted upon pressing both sides of the paddle.

ELEKEY-B: Pressing both sides of the paddle transmits the currently generated "Dash" side followed by "Dot" side (or reverse order).

ELEKEY-Y: Pressing both sides of the paddle transmits the currently generated "Dash" side followed by "Dot" side (or reverse order).

While transmitting the "Dash" side, the first transmitted "Dot" side will not be stored.

ACS: Functions as the "Keyer with automatic spacing control feature" which sets spacing between characters to be precisely the same length as a dash (three dots in length).

R KEYER DOT/DASH

Function: Reverses the connections of the CW paddle rear panel key jack.

Available Values: NOR / REV

Default Setting: NOR

Description:

NOR: Press the right side of the paddle to transmit the "Dot" signal and press the left side of the paddle to transmit the "Dash" signal.

REV: Press the left side of the paddle to transmit the "Dash" signal and press the right side of the paddle to transmit the "Dot" signal.

CW WEIGHT

Function: Adjusts the keyer CW weight.

Available Values: 2.5 - 4.5

Default Setting: 3.0

Description: Sets the "Dot": "Dash" ratio for the built-in electronic keyer.

NUMBER STYLE

Function: Selects the contest number "Cut" format for an imbedded contest number.

Available Values: 1290 / AUNO / AUNT / A2NO / A2NT / 12NO / 12NT

Default Setting: 1290

Description: Abbreviates numbers "One", "Two", "Nine" and "Zero" using Morse code when sending the contest number.

1290: Does not abbreviate the contest number.

AUNO: Abbreviates to "A" for "One", "U" for "Two", "N" for "Nine", and "O" for "Zero".

AUNT: Abbreviates to "A" for "One", "U" for "Two", "N" for "Nine", and "T" for "Zero".

A2NO: Abbreviates to "A" for "One", "N" for "Nine", and "O" for "Zero". Does not abbreviate number "Two".

A2NT: Abbreviates to "A" for "One", "N" for "Nine", and "T" for "Zero". Does not abbreviate number "Two".

12NO: Abbreviates to "N" for "Nine", and "O" for "Zero". Does not abbreviate numbers "One" and "Two".

12NT: Abbreviates to "N" for "Nine", and "T" for "Zero". Does not abbreviate numbers "One" and "Two".

CONTEST NUMBER

Function: Enters the initial contest number that will increment/decrement each time the CW message is sent during contest QSOs.

Available Values: 1 - 999

Default Setting: 1

CW MEMORY 1

Function: Selects the registration method for the contest keyer "CW MEMORY 1".

Available Values: TEXT / MESSAGE

Default Setting: TEXT

Description:

TEXT: Use the optional FH-2 or the touch panel to enter text (page 63).

MESSAGE: Use the keyer to register text to the contest memory keyer (page 61).

CW MEMORY 2

Function: Selects the registration method for the contest keyer "CW MEMORY 2".

Available Values: TEXT / MESSAGE

Default Setting: TEXT

Description:

TEXT: Use the optional FH-2 or the touch panel to enter text (page 63).

MESSAGE: Use the keyer to register text to the contest memory keyer (page 61).

CW MEMORY 3

Function: Selects the registration method for the contest keyer "CW MEMORY 3".

Available Values: TEXT / MESSAGE

Default Setting: TEXT

Description:

TEXT: Use the optional FH-2 or the touch panel to enter text (page 63).

MESSAGE: Use the keyer to register text to the contest memory keyer (page 61).

CW MEMORY 4

Function: Selects the registration method for the contest keyer "CW MEMORY 4".

Available Values: TEXT / MESSAGE

Default Setting: TEXT

Description:

TEXT: Use the optional FH-2 or the touch panel to enter text (page 63).

MESSAGE: Use the keyer to register text to the contest memory keyer (page 61).

CW MEMORY 5

Function: Selects the registration method for the contest keyer "CW MEMORY 5".

Available Values: TEXT / MESSAGE

Default Setting: TEXT

Description:

TEXT: Use the optional FH-2 or the touch panel to enter text (page 63).

MESSAGE: Use the keyer to register text to the contest memory keyer (page 61).

REPEAT INTERVAL

Function: Sets the interval time between each repetition of the beacon message.

Available Values: 1 - 60 (sec)

Default Setting: 5 sec

Description: Set the interval for transmitting the CW code registered in the contest memory keyer as a beacon. On the "CW MESSAGE MEMORY" screen, press and hold the number registered with the code to be sent. The CW Morse code message will be transmitted at the set intervals.

CW SETTING - DECODE CW -

CW DECODE BW

Function: Selects the bandwidth of the AFC feature.

Available Values: 25 / 50 / 100 / 250 (Hz)

Default Setting: 100Hz

OPERATION SETTING - GENERAL -

DECODE RX SELECT

Function: Sets the band to decode in CW, RTTY and PSK mode.

Available Values: MAIN / SUB
Default Setting: MAIN

HEADPHONE MIX

Function: Selects one of three audio mixing modes when using headphones during Dual Receive operation.

Available Values: SEPARATE / COMBINE-1 / COMBINE-2

Default Setting: SEPARATE

Description:

SEPARATE: Audio from the MAIN band receiver is heard only in the left ear, and SUB band receiver audio solely in the right ear.

COMBINE-1: Audio from both MAIN band and SUB band receivers can be heard in both ears, but SUB band audio is attenuated in the left ear and MAIN band audio is attenuated in the right ear.

COMBINE-2: Audio from both MAIN band and SUB band receivers is combined and heard equally in both ears.

ANT3 SELECT

Function: Operation selections for “ANT 3/RX” connector.

Available Values: TRX / R3-T1 / R3-T2 / RX-ANT
Default Setting: TRX

Description: Set the operation of the rear panel antenna connector “ANT 3/RX”.

TRX: Both transmit & receive at the ANT 3/RX connector.

R3-T1: The ANT 3/RX connector performs receive, and the ANT 1 connector performs transmit.

R3-T2: The ANT 3/RX connector performs receive, and the ANT 2 connector performs transmit.

RX-ANT: Receive and transmit operations are prohibited at the ANT 3/RX connector.

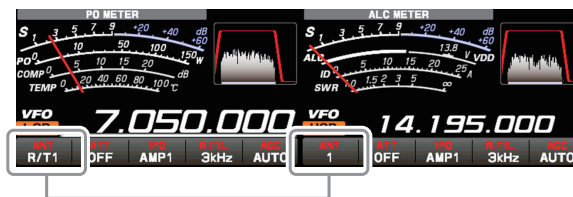

Setting of ANT 3/RX	Display	Function
-	1	Transmit & receive at the ANT 1 connector.
-	2	Transmit & receive at the ANT 2 connector.
TRX	3	Transmit & receive at the ANT 3/RX connector.
R3-T1	R/T1	The ANT 3/RX connector performs receive, and the ANT 1 connector performs transmit.
R3-T2	R/T2	The ANT 3/RX connector performs receive, and the ANT 2 connector performs transmit.
RX-ANT	RANT	Receive and transmit operations are prohibited at the ANT 3/RX connector.

NB WIDTH

Function: Sets the duration of the noise blanking pulse to match various types of noise compatible with the noise blanker function.

Available Values: 1 / 3 / 10 (msec)

Default Setting: 3msec

Description: Reduces long duration noise as well as pulse noise by changing the setting.

NB REJECTION

Function: Selects the level of noise attenuation.

Available Values: 10 / 30 / 40 (dB)

Default Setting: 30dB

BEEP LEVEL

Function: Sets the beep volume level.

Available Values: 0 - 100

Default Setting: 10

Description: The higher the setting, the louder the sound becomes.

RF/SQ/SQL VR

Function: Selects the operation mode of the RF/SQL knob.

Available Values: RF / SQL

Default Setting: RF

Description:

RF: Functions as the RF gain adjustment knob.

SQL: Functions as the Squelch level adjustment knob.

TUNER SELECT

Function: Internal and external antenna tuner settings.

Available Values: INT / EXT1 / EXT2 / EXT3

Default Setting: INT

Description: Select whether to use the “built-in antenna tuner” or the “external antenna tuner”. When using an external antenna tuner, select the antenna connector to be connected.

INT: Use the built-in antenna tuner. External antenna tuner cannot be used.

EXT1: Use an external antenna tuner connected to the ANT 1 connector.

EXT2: Use an external antenna tuner connected to the ANT 2 connector.

EXT3: Use an external antenna tuner connected to the ANT 3/RX connector.

Note: The RS-232C terminal cannot be used while using the external antenna tuner. The built-in antenna tuner cannot be used with an antenna connector connected to an external antenna tuner.

232C RATE

Function: Sets the baud rate for a RS-232C jack CAT input.

Available Values: 4800 / 9600 / 19200 / 38400 bps

Default Setting: 4800 bps

232C TIME OUT TIMER

Function: Time-Out-Timer for an RS-232C command input.

Available Values: 10 / 100 / 1000 / 3000 (msec)

Default Setting: 10 msec

Description: Sets the Time-Out-Timer countdown time for an RS-232C command input.

CAT RATE

Function: Sets the baud rate for a CAT command input of the USB jack.

Available Values: 4800 / 9600 / 19200 / 38400 bps

Default Setting: 4800 bps

CAT TIME OUT TIMER

Function: Sets the Time-Out Timer for a CAT command input.

Available Values: 10 / 100 / 1000 / 3000 (msec)

Default Setting: 10 msec

Description: Sets the Time-Out Timer countdown time for a CAT command input of the USB jack.

CAT RTS

Function: Configures the CAT RTS port setting.

Available Values: OFF / ON

Default Setting: ON

Description: Monitors the computer using the RTS signal.

ON: Monitors the computer status using the RTS signal.

OFF: Disables the monitoring function.

QMB CH

Function: Number of channels setting of the Quick Memory bank.

Available Values: 5ch / 10ch

Default Setting: 5ch

Description: Set the number of channels that can be registered in the Quick Memory Bank.

MEM GROUP

Function: Sets the memory group function.

Available Values: OFF / ON

Default Setting: OFF

Description: Set this setting to “ON” to divide the memory channels into 6 groups.

QUICK SPLIT INPUT

Function: Input a Quick Split offset frequency.

Available Values: OFF / ON

Default Setting: OFF

Description: When this setting “ON”, the Quick Split offset frequency can be input from the on-screen keyboard.

QUICK SPLIT FREQ

Function: Selects the amount the frequency is offset when the Quick Split feature is enabled.

Available Values: -20 - 0 - 20kHz (1 kHz/step)

Default Setting: 5kHz

- Press and hold the [SPLIT] key to activate SUB Band split frequency operation, thereby offsetting the transmitter by the specified frequency.
- Each time the [SPLIT] key is pressed and held, the frequency offset is increased by the setting amount.

TX TIME OUT TIMER

Function: Sets the Time-Out Timer countdown time.

Available Values: OFF / 1 - 30 min

Default Setting: OFF

Description: When the time-out timer function is active, a beep is emitted when a continuous transmission nears the set time. About 10 seconds later, the transceiver is forced to return to the receiving mode.

MIC SCAN

Function: Activates the microphone automatic scanning function.

Available Values: OFF / ON

Default Setting: ON

Description: Sets the operation of the UP/DWN keys on the microphone.

ON: Starts scanning automatically by pressing and holding the UP/DWN key for 1 second or more (Scanning continues even after releasing the button). To stop scanning, press the UP/DWN key again briefly or press the PTT button to transmit.

OFF: Scans only while pressing and holding the UP/DWN key. To stop scanning, release the button.

MIC SCAN RESUME

Function: Sets the Scan Resume function.

Available Values: PAUSE / TIME

Default Setting: TIME

Description:

PAUSE: During automatic scanning, the scanner will hold until the signal disappears.

TIME: If the signal does not disappear within five seconds, the scanner will resume scanning for the next active channel (frequency).

If there are no signals, the scanner continues scanning.

REF FREQ FINE ADJ

Function: Adjusts the reference oscillator.

Available Values: -25 - 0 - 25

Default Setting: 0

Description: The frequency may be calibrated by connecting a frequency counter to the transceiver, or by receiving a standard frequency such as WWV or WWVH.

CS DIAL

Function: Sets the Operation of MPVD dial when the [C.S] key is pressed.

Available Values: RF POWER / MONI LVL / DNR LVL / NB LVL / VOX GAIN / VOX DELAY / ANTI VOX / STEP DIAL / MEM CH / GROUP / R.FIL

Default Setting: MEM CH

Description:

RF POWER: Adjusts transmit output.

MONI LVL: Adjusts the Monitor volume.

DNR LVL: DNR level adjustment.

NB LVL: NB level adjustment.

VOX GAIN: VOX gain adjustment.

VOX DELAY: VOX delay adjustment.

ANTI VOX: ANTI VOX adjustment.

STEP DIAL: Set the Frequency Change Steps.

MEM CH: Selects the Memory Channels.

GROUP: Selects the Memory Group.

R.FIL: Selects the Roofing filter Pass Band Width.

KEYBOARD LANGUAGE

Function: Selects the keyboard language.

Available Values: JAPANESE / ENGLISH(US)

ENGLISH(UK) / FRENCH

FRENCH(CA) / GERMAN

PORTUGUESE

PORTUGUESE(BR)

SPANISH / SPANISH(LATAM)

ITALIAN

Default Setting: Depends on the transceiver version.

OPERATION SETTING - RX DSP -

APF WIDTH

Function: Sets the bandwidth of the Audio Peak Filter.

Available Values: NARROW / MEDIUM/WIDE

Default Setting: MEDIUM

Description: In CW mode the APF peak center frequency is set according to the CW PITCH frequency and the chosen APF bandwidth value. In order to listen to the desired signal comfortably, select one of the three bandwidths of the peak filter.

CONTOUR LEVEL

Function: Adjusts the GAIN of the CONTOUR circuit.

Available Values: -40 - 0 - 20

Default Setting: -15

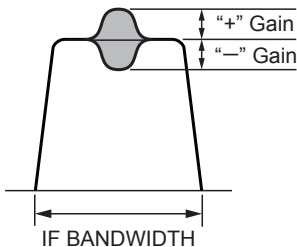

CONTOUR WIDTH

Function: Sets the bandwidth ("Q") of the CONTOUR circuit.

Available Values: 1 - 11

Default Setting: 10

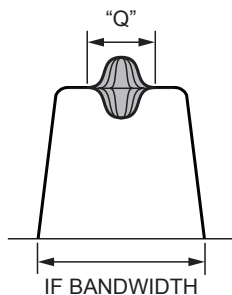

DNR LEVEL

Function: Set the Digital Noise Reduction response.

Available Values: 1 - 15

Default Setting: 1

IF NOTCH WIDTH

Function: Sets the attenuation bandwidth characteristic of the DSP IF notch filter.

Available Values: NARROW / WIDE

Default Setting: WIDE

Description: Sets the attenuation bandwidth characteristic setting of the DSP IF notch filter to "NARROW" or "WIDE".

OPERATION SETTING - TX AUDIO -

PROC LEVEL

Function: Sets the level of the AMC function and the speech processor function compression level adjustment.

Available Values: COMP / AMC

Default Setting: AMC

Description:

COMP: Press the [MIC/SPEED] knob to turn the speech processor function ON and then adjust the compression level with the [PROC/PITCH] knob. When the speech processor function is turned OFF, the level of the AMC function may be adjusted with the [PROC/PITCH] knob.

AMC: The [PROC/PITCH] knob acts as the level control knob for the AMC function, regardless of whether the speech processor function is ON or OFF.

AMC RELEASE TIME

Function: AMC level adjustment tracking speed setting

Available Values: FAST / MID / SLOW

Default Setting: MID

Description: Set the input audio level tracking speed of the AMC function.

PRMTRC EQ1 FREQ

Function: Sets the center frequency of the low range for the 3 band parametric microphone equalizer.

Available Values: OFF / 100 - 700 (Hz)

Default Setting: OFF

Description: Selects the center frequency of the low range of the 3 Band Parametric Microphone Equalizer in 100Hz steps between "100Hz" and "700Hz".

PRMTRC EQ1 LEVEL

Function: Sets the gain for the low range of the 3 Band Parametric Microphone Equalizer.

Available Values: -10 - 0 - 10 (dB)

Default Setting: 5

Description: Adjusts the gain for the low range of the 3 Band Parametric Microphone Equalizer between "-10 dB" and "+10 dB".

PRMTRC EQ1 BWTH

Function: Sets the width variation (“Q”) for the low range of the 3 Band Parametric Microphone Equalizer.

Available Values: 0 - 10

Default Setting: 10

Description: Selects the value of the width (Q) for the low range for the 3 Band Parametric Microphone Equalizer between “0” and “10”.

PRMTRC EQ2 FREQ

Function: Sets the center frequency for the middle range of the 3 Band Parametric Microphone Equalizer.

Available Values: OFF / 700 - 1500 (Hz)

Default Setting: OFF

Description: Sets the center frequency for the middle range of the 3 Band Parametric Microphone Equalizer in 100 Hz steps between “700 Hz” and “1500 Hz”.

PRMTRC EQ2 LEVEL

Function: Sets the gain for the middle range of the 3 Band Parametric Microphone Equalizer.

Available Values: -10 - 0 - 10 (dB)

Default Setting: 5

Description: Selects the gain setting for the middle range of the 3 Band Parametric Microphone Equalizer between “-10 dB” and “+10 dB”.

PRMTRC EQ2 BWTH

Function: Sets the width variation (“Q”) for the middle range of the 3 Band Parametric Microphone Equalizer.

Available Values: 0 - 10

Default Setting: 10

Description: Selects the width (“Q”) for the middle range of the 3 Band Parametric Microphone Equalizer between “0” and “10”.

PRMTRC EQ3 FREQ

Function: Sets the center frequency for the high range of the 3 Band Parametric Microphone Equalizer.

Available Values: OFF/1500 - 3200 (Hz)

Default Setting: OFF

Description: Selects the center frequency setting for the high range of the 3 Band Parametric Microphone Equalizer in 100 Hz steps between “1500 Hz” and “3200 Hz”.

PRMTRC EQ3 LEVEL

Function: Sets the gain for the high range of the 3 Band Parametric Microphone Equalizer.

Available Values: -10 - 0 - 10 (dB)

Default Setting: +5

Description: Selects the gain setting for the high range of the 3 Band Parametric Microphone Equalizer between “-10 dB” and “+10 dB”.

PRMTRC EQ3 BWTH

Function: Selects the width setting (“Q”) for the high range of the 3 Band Parametric Microphone Equalizer.

Available Values: 0 - 10

Default Setting: 10

Description: Selects the width (“Q”) setting for the high range of the 3 Band Parametric Microphone Equalizer between “0” and “10”.

P PRMTRC EQ1 FREQ

Function: Sets the center frequency of the low range for the 3 Band Parametric Microphone Equalizer when the AMC or speech processor is activated.

Available Values: OFF / 100 - 700 (Hz)

Default Setting: OFF

Description: Activates when the AMC or speech processor is “ON”. Adjusts the center frequency for the low range of the 3 Band Parametric Microphone Equalizer in 100 Hz steps between “100 Hz” and “700 Hz”.

P PRMTRC EQ1 LEVEL

Function: Selects the gain setting for the low range of the 3 Band Parametric Microphone Equalizer when the AMC or speech processor is activated.

Available Values: -10 - 0 - 10 (dB)

Default Setting: 0

Description: Activates when the AMC or speech processor is “ON” and sets the gain for the low range of the 3 Band Parametric Microphone Equalizer between “-10 dB” and “+10 dB”.

P PRMTRC EQ1 BWTH

Function: Selects the width (“Q”) for the low range of the 3 Band Parametric Microphone Equalizer when the AMC or speech processor is activated.

Available Values: 0 - 10

Default Setting: 2

Description: Activates when the AMC or speech processor is “ON” and sets the width (“Q”) for the low range of the 3 Band Parametric Microphone Equalizer between “1” and “10”.

P PRMTRC EQ2 FREQ

Function: Selects the center frequency for the middle range of the 3 Band Parametric Microphone Equalizer when the AMC or speech processor is activated.

Available Values: OFF / 700 - 1500 (Hz)

Default Setting: OFF

Description: Selects the center frequency for the middle range of the 3 Band Parametric Microphone Equalizer in 100 Hz steps between "700 Hz" and "1500 Hz" when the AMC or speech processor is activated.

P PRMTRC EQ2 LEVEL

Function: Sets the gain for the middle range of the 3 Band Parametric Microphone Equalizer when the AMC or speech processor is activated.

Available Values: -10 - 0 - 10 (dB)

Default Setting: 0

Description: Selects the gain setting for the middle range of the 3 Band Parametric Microphone Equalizer between "-10 dB" and "+10 dB" when the AMC or speech processor is activated.

P PRMTRC EQ2 BWTH

Function: Sets the width ("Q") for the middle range of the 3 Band Parametric Microphone Equalizer when the AMC or speech processor is activated.

Available Values: 0 - 10

Default Setting: 1

Description: Activates when the AMC or speech processor is "ON", and selects the width ("Q") setting for the middle range of the 3 Band Parametric Microphone Equalizer between "0" and "10".

P PRMTRC EQ3 FREQ

Function: Sets the center frequency for the high range of the 3 Band Parametric Microphone Equalizer when the AMC or speech processor is activated.

Available Values: OFF/1500 - 3200 (Hz)

Default Setting: OFF

Description: Activates when the AMC or speech processor is "ON", and selects the center frequency setting for the high range of the 3 Band Parametric Microphone Equalizer in 100 Hz steps between "1500 Hz" and "3200 Hz".

P PRMTRC EQ3 LEVEL

Function: Sets the gain for the high range of the 3 Band Parametric Microphone Equalizer when the AMC or speech processor is activated.

Available Values: -10 - 0 - 10 (dB)

Default Setting: 0

Description: Activates when the AMC or speech processor is "ON", and selects the gain setting for the high range of the 3 Band Parametric Microphone Equalizer between "-10 dB" and "+10 dB".

P PRMTRC EQ3 BWTH

Function: Sets the width ("Q") for the high range of the 3 Band Parametric Microphone Equalizer when the AMC or speech processor is activated.

Available Values: 0 - 10

Default Setting: 1

Description: Activates when the AMC or speech processor is "ON", and sets the width ("Q") for the high range of the 3 Band Parametric Microphone Equalizer between "0" and "10".

OPERATION SETTING

- TX GENERAL -

HF MAX POWER

Function: Sets the transmit RF power output of the HF band.

Available Values: 5 - 200W (FTDX101MP)
5 - 100W (FTDX101D)

Default Setting: 200W (FTDX101MP)
100W (FTDX101D)

50M MAX POWER

Function: Sets the transmit RF power output of the 50 MHz band.

Available Values: 5 - 200W (FTDX101MP)
5 - 100W (FTDX101D)

Default Setting: 200W (FTDX101MP)
100W (FTDX101D)

70M MAX POWER

Function: Sets the transmit RF power output of the 70 MHz band.

Available Values: 5 - 50W

Default Setting: 50W

AM MAX POWER

Function: Sets the transmit RF power output of the AM mode.

Available Values: 5 - 50W (FTDX101MP)
5 - 25W (FTDX101D)

Default Setting: 50W (FTDX101MP)
25W (FTDX101D)

VOX SELECT

Function: Selects the function of the VOX operation.

Available Values: MIC / DATA

Default Setting: MIC

Description:

MIC: Operates via input from the MIC jack (microphone).

DATA: Operates via input from the RTTY/DATA or USB jack.

DATA VOX GAIN

Function: Sets the VOX GAIN while operating VOX during the sending/receiving of data (PSK, RTTY, etc.).

Available Values: 0 - 100

Default Setting: 50

Description: Set the data input VOX gain to the point that the data signal reliably engages the transmitter, and also releases the transmit when there is no data signal.

EMERGENCY FREQ TX

Function: Enables TX/RX operation on the Alaska Emergency Channel, 5167.5kHz.

Available Values: OFF / ON

Default Setting: OFF

Description: When this Menu Item is set to "ON", the spot frequency of 5167.5 kHz will be enabled. The Alaska Emergency Channel will be found between the PMS memory channel "M-P9U (or 5-10)" and the memory channel "M-01".

Important: The use of this frequency is restricted to stations operating in or near Alaska, and only for emergency purposes (never for routine operations). See §97.401(c) of the FCC regulations.

OPERATION SETTING - TUNING -

SSB/CW DIAL STEP

Function: Setting of the MAIN dial tuning speed in the SSB and CW mode.

Available Values: 5 / 10 (Hz)

Default Setting: 10

RTTY/PSK DIAL STEP

Function: Setting of the Main dial knob tuning speed in the RTTY and PSK mode.

Available Values: 5 / 10 (Hz)

Default Setting: 10

CH STEP

Function: Selects the tuning steps for the [MULTI] knob.

Available Values: 1 / 2.5 / 5 (kHz)

Default Setting: 2.5kHz

AM CH STEP

Function: Selects the tuning steps for the microphone [UP]/[DWN] keys and [MULTI] knob in the AM mode.

Available Values: 2.5 / 5 / 9 / 10 / 12.5 / 25 (kHz)

Default Setting: 5kHz

FM CH STEP

Function: Selects the tuning steps for the microphone [UP]/[DWN] keys and [MULTI] knob in the FM mode.

Available Values: 5 / 6.25 / 10 / 12.5 / 20 / 25 (kHz)

Default Setting: 5kHz

MAIN STEPS PER REV.

Function: Setting the step per rotation of the MAIN dial.

Available Values: 250 / 500 / 1000

Default Setting: 500

MPVD STEPS PER REV.

Function: Setting the step per rotation of the MPVD ring.

Available Values: 250 / 500

Default Setting: 500

DISPLAY SETTING - DISPLAY -

MY CALL

Function: Programs a Call Sign or Name.

Available Values: Up to 12 alphanumeric characters

Default Setting: FTDX101

Description: Set characters to be displayed on the power ON opening screen.

MY CALL TIME

Function: Set the time for displaying characters registered in "MY CALL".

Available Values: OFF / 1 / 2 / 3 / 4 / 5 (sec)

Default Setting: 1sec

Description: Set the time "My Call is displayed on the opening screen after power ON.

SCREEN SAVER

Function: Time setting before the screen saver to activate.

Available Values: OFF / 15 / 30 / 60 (min)

Default Setting: 60min

Description: If the transceiver is not operated for the set time, a screen saver will activate to prevent TFT screen burns.

TFT CONTRAST

Function: Sets the TFT contrast level.

Available Values: 0 - 20

Default Setting: 10

TFT DIMMER

Function: Sets the TFT display brightness level.

Available Values: 0 - 20

Default Setting: 15

Description: The higher the setting, the brighter the illumination becomes.

LED DIMMER

Function: Sets the key LED brightness level.

Available Values: 0 - 20

Default Setting: 10

Description: The higher the setting, the brighter the illumination becomes.

MOUSE POINTER SPEED

Function: Mouse pointer movement speed setting.

Available Values: 0 - 20

Default Setting: 10

Description: The higher the setting, the faster the Mouse pointer will move.

FREQ STYLE

Function: Frequency display font setting.

Available Values: LIGHT (thin) / BOLD (thick)

Default Setting: BOLD

DISPLAY SETTING - SCOPE -

RBW

Function: Sets the resolution of Spectrum Scope display.

Available Values: HIGH / MID / LOW

Default Setting: HIGH

Description: When set to HIGH, the image is finely divided.

SCOPE CTR

Function: Sets the scope screen center and marker position.

Available Values: FILTER / CAR POINT

Default Setting: CAR POINT

Description:

FILTER: Relative to the center of the filter.

CAR POINT: Based on signal carrier points.

2D DISP SENSITIVITY

Function: Change the Waterfall Display sensitivity.

Available Values: NORMAL / HI

Default Setting: HI

Description:

NORMAL: Display at normal sensitivity.

HI: Display at high sensitivity.

3DSS DISP SENSITIVITY

Function: Change the 3DSS Display sensitivity.

Available Values: NORMAL / HI

Default Setting: HI

Description:

NORMAL: Display at normal sensitivity.

HI: Display at high sensitivity.

DISPLAY SETTING - EXT MONITOR -

EXT DISPLAY

Function: Video signal output setting of the EXT-DISPLAY terminal on the rear panel.

Available Values: OFF / ON

Default Setting: OFF

Description:

OFF: No video signal output.

ON: Video signal is output.

PIXEL

Function: Select the screen resolution of the external video monitor.

Available Values: 800x480 / 800x600

Default Setting: 800x480

EXTENSION SETTING - DATE & TIME -

DAY

Set the date (Day).

MONTH

Set the date (Month).

YEAR

Set the date (Year).

HOUR

Set the time (Hour).

Set to 24-hour format.

MINUTE

Set the time (Minute).

EXTENSION SETTING - SD CARD -

MEM LIST LOAD

Function: Load the Memory Channel information saved on the SD memory card into the transceiver.

MEM LIST SAVE

Function: Save the Memory Channel information to the SD memory card.

MENU LOAD

Function: Load the Setting Menu information saved on the SD memory card into the transceiver.

MENU SAVE

Function: Save the Setting Menu information to the SD memory card.

INFORMATIONS

Function: Display information from SD Memory Card.

Description: Displays the total capacity and free space of the SD Memory Card.

FIRMWARE UPDATE

Function: Update the firmware of the FTDX101 series.

Description: When a new firmware update for the FTDX101 series is available, go to the YAESU web site to download the programming data and update the FTDX101 series Firmware.

FORMAT

Function: Format (initialize) the SD memory card.
Description: Format a micro SD Memory Card for use with this transceiver.

EXTENSION SETTING - SOFT VERSION -

Description: Displays the software version.

EXTENSION SETTING - CALIBRATION -

CALIBRATION

Function: Display touch position calibration.

Description: If the touch position and the operation are different, that is touch does not work or another function works, perform touch position calibration of the TFT display.

1. Select [CALIBRATION] then press the [MULTI] knob.
2. Touch "+" at the top left of the display. To cancel the calibration, press the [S.MENU] key.
3. Touch "+" displayed at another place.
4. Repeat step 3 and finally touch "+" in the center of the display to complete the calibration.

EXTENSION SETTING - RESET -

MEMORY CLEAR

Function: Memory reset

Description: Only the information stored in the Memory Channel is initialized (all erased).



The contents of the memory channel "M-01" will return to the initial setting "7.00.000 MHz, LSB" and cannot be deleted.



Memory information can be saved on the SD card.

MENU CLEAR

Function: Setting Menu reset

Description: Only the contents of the Setting Menu is initialized (factory default).



Information in the setting menu can be saved on the SD card.

ALL RESET

Function: ALL reset

Description: The Memory, Setting Menu and all other settings are initialized and set to the factory default.

Resetting the Microprocessor

Memory channels, setting menus, and various settings can be initialized and returned to their factory defaults.

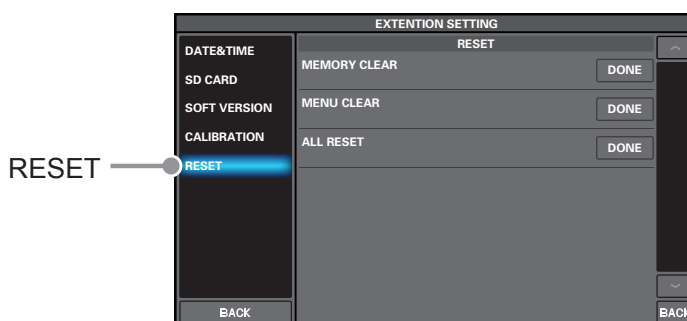
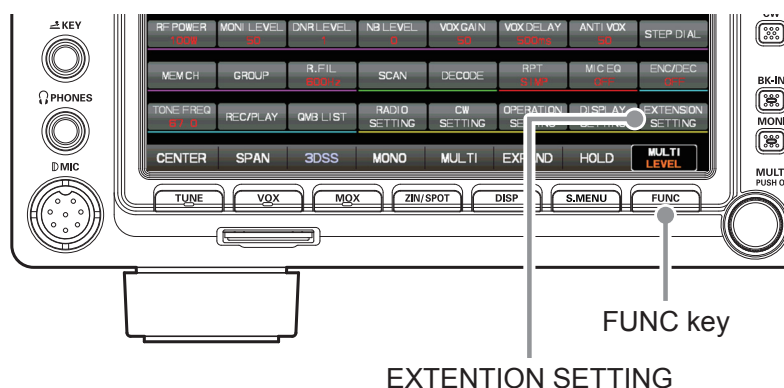

1. Display the reset item selection screen.
Select [FUNC] → [EXTENSION SETTING] → [RESET]
2. Touch “DONE” of the item you want to reset (see below).
Or Select an item with the [MULTI] dial and press the [MULTI] dial.
A confirmation screen for reset execution is displayed.

MEMORY CLEAR (Memory Reset)

Only the contents of the memory channel are initialized (factory default).

All stored information will be erased, but channel M-01 will return to the initial setting of 7.000.000 MHz, LSB.

MENU CLEAR (Setting Menu Reset)

Only the contents of the setting menu are returned to their default values (factory default).

ALL RESET (All Reset)

Initializes all settings of this unit, including various settings, memories, and setting menus, and restores the factory settings.

3. Touch [OK] or select [OK] with the [MULTI] dial and press the [MULTI] dial to execute the reset.
To cancel the reset, touch [CANCEL] or select [CANCEL] with the [MULTI] dial and press the [MULTI] dial.
4. The power is turned off once and then turned on automatically.
The reset is complete.

Optional Accessories

FC-40 External Automatic Antenna Tuner (for Wire Antenna)

The FC-40 makes use of the control circuitry built into the transceiver, which allows the operator to control and monitor automatic operation of the FC-40, which mounts near the antenna feedpoint. The FC-40 uses specially selected, thermally stable components, and is housed in a waterproof case to withstand severe environmental conditions with high reliability.

A carefully-chosen combination of solid-state switching components and high-speed relays allows the FC-40 to match a wide variety of antennas to within a 2:1 SWR on any amateur band frequency (160 through 6 meters), typically in less than eight seconds. Transmitter power required for matching may be as little as 4 - 60 Watts, and matching settings are automatically stored in memory for instant recall when the same frequency range is selected later.

Please see the FC-40 Operating Manual for detailed information.



Depending on the installation and location of some antennas, it may not be possible to tune to a low SWR.

• Interconnections to FTDX101 series

After mounting the FC-40, connect the cables from the FC-40 to the ANT and TUNER jacks on the rear panel of the FTDX101 series Transceiver.

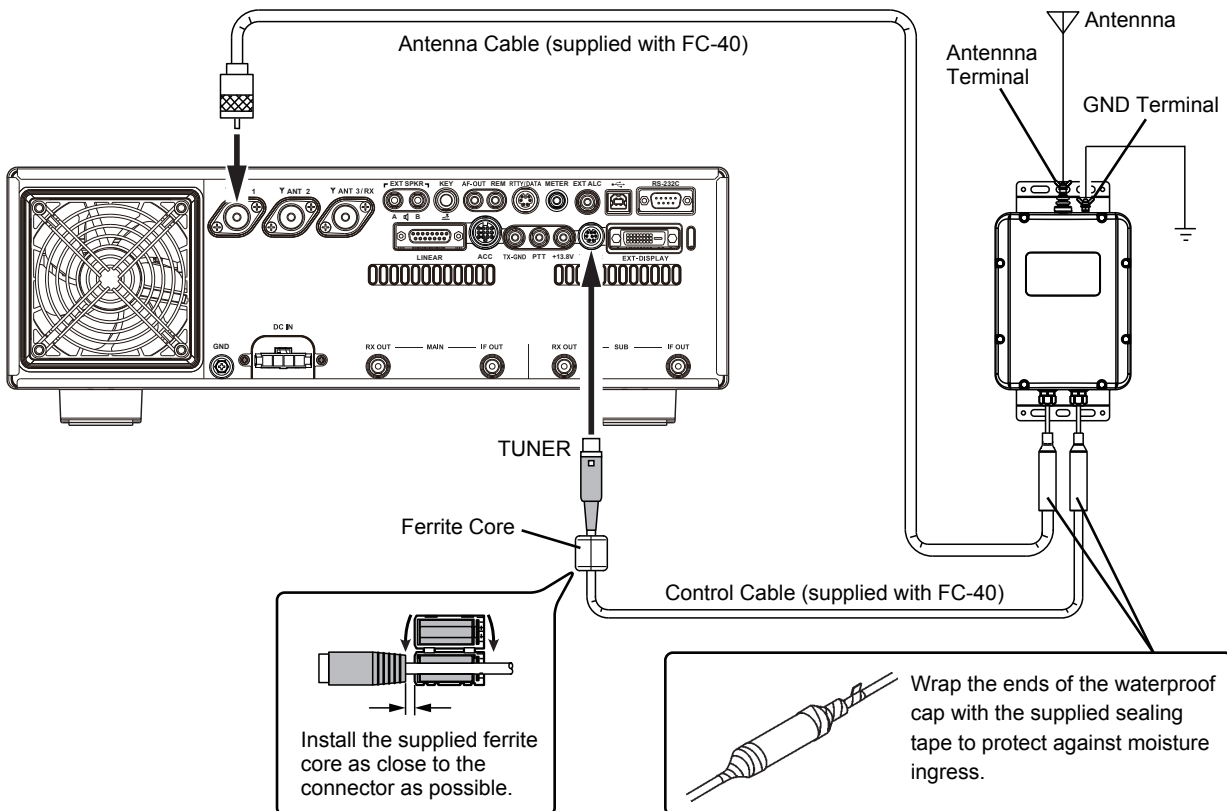

• Setup the FTDX101 series

The optional FC-40 Automatic Antenna Tuner provides automatic tuning of a coaxial line to present nominal 50-ohm impedance to the FTDX101's ANT jack.

Before tuning can begin, the FTDX101 must be configured to recognize that the FC-40 is being used.

Configuration is done using the Setting Menu Mode:

1. Press the [FUNC] key.
2. Select [OPERATION SETTING] → [GENERAL] → [TUNER SELECT].
3. Select the antenna connector to which FC-40 is connected.

EXT1: When connected to ANT 1 connector.

EXT2: When connected to ANT 2 connector.

EXT3: When connected to ANT 3/RX connector.

4. Press the [FUNC] key to save the new setting and exit the Setting Menu.
5. Press the [FUNC] key to exit to normal operation.



- The built-in antenna tuner and RS-232C jack cannot be used during operation with the antenna connector connected with FC-40.
- When using FC-40 with FTDX101MP, the maximum transmit power of the antenna connector connected with FC-40 will be 100W automatically.

Operation

1. Press the [TUNE] key.
The LED inside the [TUNE] key glows orange; and the tuner function is activated.

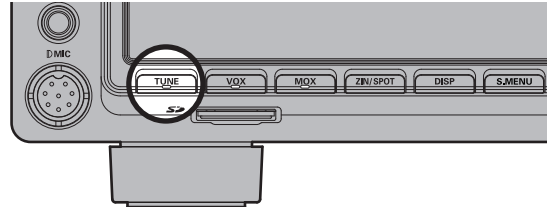

2. Press and hold the [TUNE] key to begin automatic tuning.
 - The transmitter will be engaged, and the LED in the [TUNE] key will blink while tuning is in progress.
 - When the optimum tuning point has been reached, the transceiver will return to receive, and the LED in the [TUNE] key will again glow steadily (instead of blinking).

- Be sure to connect a good earth ground to the GND terminal of the FC-40.
- The carrier signal transmits continuously while tuning is in progress. Please monitor the operating frequency before beginning the tuning process. Be sure you are not interfering with others who may already be using the frequency.
- It is normal to hear the sound of the relays while tuning is in progress.
- If the impedance cannot be matched by the FC-40 better than 2:1, and the "HI-SWR" icon blinks, the microprocessor will not retain the tuning data for that frequency, as the FC-40 presumes that you will want to adjust or repair the antenna system to correct the high SWR condition.

Optional FH-2 Control

With the optional remote-control keypad FH-2 voice messages may be recorded and transmitted (Voice Memory). The FH-2 is also the control of the Contest Memory Keyer during CW operation.

- SSB / AM / FM modes have five voice memory channels (20 seconds each) for storage and playback, of voice recordings (page 54).
- The CW Memory Keyer has 5 channels each for the MESSAGE Memory and the TEXT Memory (page 61).

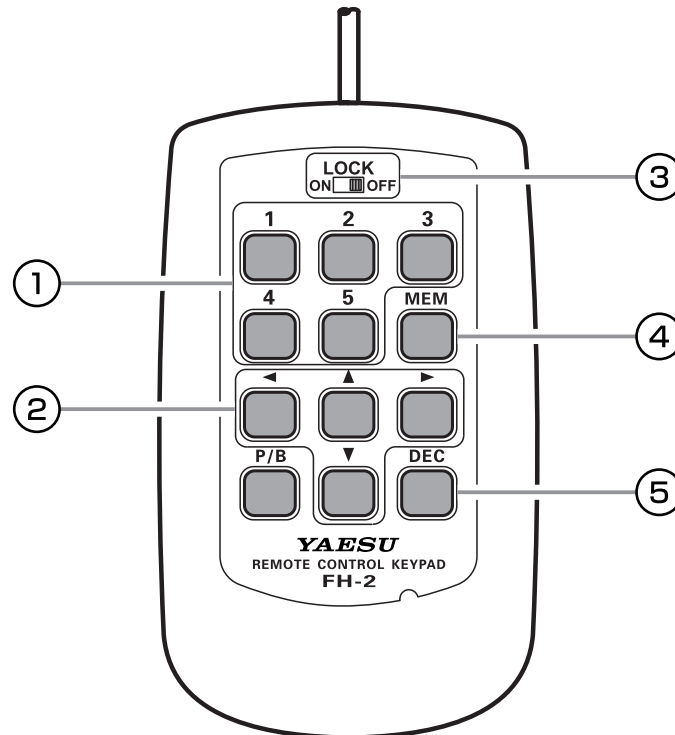

① Voice Memory: 5 Memory Channels for the Memory Keyer

In the case of Voice Memory, up to 20 seconds of audio may be stored on each channel.

"MESSAGE Memory" and "TEXT Memory" are available for the Contest Memory Keyer.

Each "MESSAGE Memory" channel is capable of retaining a 50-character CW message using the PARIS standard for characters and word length.

Each "TEXT Memory" channel is capable of retaining a maximum of 50 characters.

② Cursor Keys

When programming the Contest Memory Keyer, these keys are used to move the cursor and select the text characters.

The cursor may be moved in 4 different directions (up/down/right/left).

NOTE: Usually, these keys are used for changing the VFO frequency. Press the [▲]/[▼] keys to change the frequency in the same increments as the microphone [UP]/[DWN] switches. Press the [◀]/[▶] keys to change the frequency by 100 kHz steps.

③ LOCK Switch

The FH-2 key keys may be locked by setting this switch to "ON".

④ MEM Key

Press this key to store either a Voice Memory, or a Contest Keyer Memory.

⑤ DEC Key

When utilizing the sequential contest number capability of the Contest Keyer, press this key to decrement (decrease) the current Contest Number by one digit (i.e. to back up from #198 to #197, etc.).

*No function is assigned to the [P/B] key.

Specifications

General

Tx Frequency Ranges:	1.8 MHz - 54 MHz (Amateur bands only) 70 MHz - 70.5 MHz (UK Amateur bands only)
Rx Frequency Range:	30 kHz - 75 MHz (operating) 1.8 MHz - 29.699999 MHz (Specified performance, Amateur bands only) 50 MHz - 53.999999 MHz (Specified performance, Amateur bands only) 70 MHz - 70.499999 MHz (Specified performance, UK Amateur bands only)
Emission Modes:	A1A (CW), A3E (AM), J3E (LSB, USB), F3E (FM), F1B (RTTY), G1B (PSK31)
Frequency Steps:	1/5/10 Hz (SSB, CW), 10/100 Hz (AM, FM)
Antenna Impedance:	50 ohms, unbalanced (Antenna Tuner OFF) 16.7 - 150 ohms, unbalanced (Tuner ON, 1.8 MHz - 29.7 MHz Amateur bands) 25 - 100 ohms, unbalanced (Tuner ON, 50 MHz Amateur band)
Operating Temperature Range:	+32 °F to +122 °F (0 °C to +50 °C)
Frequency Stability:	±0.1 ppm (after 1 minute @+14 °F to +140 °F [-10 °C to +60 °C])
Supply Voltage:	AC 100 V/200 V (FTDX101MP) DC 13.8 V ± 10% (Negative Ground)(FTDX101D)
Power Consumption (Approx.):	Rx (no signal) 100VA (FTDX101MP) 3.5 A (FTDX101D) Rx (signal present) 120VA (FTDX101MP) 4 A (FTDX101D) Tx 720VA (FTDX101MP: 200 W) 23 A (FTDX101D: 100 W)
Dimensions (WxHxD):	16.6" x 5.1" x 12.7" (420 x 130 x 322 mm)
Weight (Approx.):	31.5 lbs (14.3 kg): FTDX101MP 26.5 lbs (12 kg): FTDX101D

Transmitter

Power Output:	FTDX101MP: 5 - 200 W (5 - 50 W AM carrier) FTDX101D: 5 - 100 W (5 - 25 W AM carrier)
Modulation Types:	J3E (SSB): Balanced A3E (AM): Low-Level (Early Stage) F3E (FM): Variable Reactance
Maximum FM Deviation:	±5.0kHz/±2.5kHz (Narrow)
Harmonic Radiation:	Better than -50 dB (1.8 MHz - 29.7 MHz Amateur bands) Better than -66 dB (50 MHz Amateur band: 200 W) Better than -63 dB (50 MHz Amateur band: 100 W)
SSB Carrier Suppression:	At least 60 dB below peak output
Undesired Sideband Suppression:	At least 60 dB below peak output
Bandwidth:	3 kHz (LSB/USB), 500 Hz (CW), 6 kHz (AM), 16 kHz (FM)
Audio Response (SSB):	Not more than -6 dB from 300 to 2700 Hz
Microphone Impedance:	600 ohms (200 to 10 k-ohms)

Receiver

Circuit Type:	Double Superheterodyne		
Intermediate Frequencies:	1 st: 9.005 MHz (MAIN), 8.9000 MHz (SUB)		
	2 nd: 24 kHz (MAIN/SUB)		
Sensitivity (TYP):	SSB/CW (BW: 2.4 kHz/10 dB S+N/N)		
	1.8 MHz - 30 MHz	0.16 μ V (AMP2 "ON")	
	50 MHz - 54 MHz	0.125 μ V (AMP2 "ON")	
	70MHz - 70.5MHz	0.16 μ V (AMP2 "ON")	
	AM (BW: 6 kHz/10dB S+N/N, 30% modulation @400 Hz)		
	0.5 MHz - 1.8 MHz	6.3 μ V	
	1.8 MHz - 30 MHz	2 μ V (AMP2 "ON")	
	50 MHz - 54 MHz	1 μ V (AMP2 "ON")	
	70MHz - 70.5MHz	2 μ V (AMP2 "ON")	
	FM (BW: 12 kHz, 12 dB SINAD)		
	28 MHz - 30 MHz	0.25 μ V (AMP2 "ON")	
	50 MHz - 54 MHz	0.2 μ V (AMP2 "ON")	
	70MHz - 70.5MHz	0.25 μ V (AMP2 "ON")	
Squelch Sensitivity (TYP):	SSB/CW/AM		
	2 μ V (1.8MHz - 30MHz, 50MHz - 54MHz) (AMP2 "ON")		
	FM	0.25 μ V (28MHz - 30MHz) (AMP2 "ON")	
		0.2 μ V (50MHz - 54MHz) (AMP2 "ON")	
Selectivity (WIDTH: Center):	Mode	-6 dB	-60 dB
	CW (BW: 0.5 kHz)	0.5 kHz or better	750 Hz or less
	SSB (BW: 2.4 kHz)	2.4 kHz or better	3.6 kHz or less
	AM (BW: 6 kHz)	6 kHz or better	15 kHz or less
	FM (BW: 12 kHz)	12 kHz or better	25 kHz or less
IF Rejection:	60 dB or better (1.8 MHz - 28 MHz Amateur bands, VC-tune "ON")		
	60 dB or better (50 MHz Amateur bands)		
Image Rejection:	70 dB or better (1.8 MHz - 28 MHz Amateur bands)		
	60dB or better (50 MHz - 54 MHz Amateur bands)		
Maximum Audio Output:	2.5 W into 4 ohms with 10 % THD		
Audio Output Impedance:	4 to 16 ohms (4 ohms: nominal)		
Conducted Radiation:	Less than 4 nW		

Specifications are subject to change, in the interest of technical improvement, without notice or obligation, and are guaranteed only within the amateur bands.

Symbol placed on the equipment

== Direct current

+13.8V	17
3DSS	25

A

About TFT Displays	29
ACC	17
Accessories	8
Adjustable Receiver Audio Filter	55
Adjust contrast	30
Adjusting the brightness	30
Adjusting the Clock	80
Adjusting the Date	80
Adjusting the Sidetone Audio level	58
AF (MAIN)	42
AF-OUT	16
AF (SUB)	43
AGC	23
Alaska Emergency Frequency: 5167.5 kHz	79
AMC	50
ANT	22
ANT 1, 2, 3/RX	16
Antenna Connections	9
Antenna Considerations	9
APF	47
ATT	22
ATU	56
Audio Peak Filter	47
Automatic Antenna Tuner	56
Automatic Mic Gain Control	50

B

BAND	35
Band Stack Operation	78
BK-IN	36

C

CENTER	24
Check Memory Channel Status	73
Clarifier	39
COLOR	27
CONT	46
Contest Memory Keyer	61
Contest Number	64
Contour	46
C.S	40
CURSOR	24
Custom selection	40
CW	36
CW Decode	59
CW Delay Time Setting	58
CW Mode Operation	58

D

DATA (PSK) Operation	69
DC IN	17

Digital Noise Reduction	45
Digital NOTCH Filter	45
DISP	26
Display Indications	20
DNF	45
DNR	45

E

Electronic Keyer	60
Erasing Memory Channel Data	72
EXPAND	26
EXT ALC	17
EXT-DISPLAY	17
EXT SPKR	16

F

FAST	34
FC-40 External Automatic Antenna Tuner	112
FH-2 Connections	13
FH-2 Control	114
Filter Function Display	21
FINE TUNING	34
FIX	25
FM Mode Operation	65
Font setting for frequency display	30
Frequency Display	21
Front Panel Controls & Switches	32
Function Menu Display	28

G

General Description	4
GND	17

H

Headphone Connections	13
HOLD	26

I

IF NOTCH Filter	45
IF OUT (MAIN)	17
IF OUT (SUB)	17
Important Receiver Settings	22
Inputting the Call Sign	30
Installation and Interconnections	9
IPO	22

K

KEY	16, 32
Key and Keyer Connections	13
Keyboard Frequency Entry	21
Keyer Speed	60
Keyer Weight (Dot/Dash) Ratio	60

L

Labeling Memories	74
LEVEL	27
LINEAR	17
Linear Amplifier Interconnections	14
LOCK	34

M

MAIN dial	34
MARKER	27
Memory Groups	75
Memory Operation	72
Memory Scanning	76
METER	16
Meter Display	20
MIC	32, 43
Microphone Connections	13
Microphone gain	50
MODE	36
MONI	36
MONO	25
MOX	33
MPVD ring	38
MULTI	26

N

NB	44
NOTCH	45

O

ON/OFF Switch	32
Operating Band Selection	35
Operation of the Display MULTI Knob	28
Options	8
Other Functions	78
Other On-Screen Indications	29

P

Parametric Microphone Equalizer	52
PEAK	27
PHONES Jack	32
PITCH	43
PMS (Programmable Memory Scan)	77
Power Cable Connections	10
PROC	43
Programmable Memory Scan	77
PSK Decode	70
PSK Text Memory	71
PTT	17

Q

QMB	35
Quick Memory Bank	35
Quick Split Operation	37

R

Rear Panel	16
REM	16
Repeater Operation	65
Resetting the Microprocessor	111
Reversing the Keyer Polarity	60
R.FIL	23
RF (MAIN)	42
RF Power output control	51
RF (SUB)	43
RS-232C	17
RTTY/DATA	16
RTTY Decode	67
RTTY (FSK) Operation	66
RTTY Text Memory	68
RX Clarifier	39
RX (MAIN)	41
RX OUT (MAIN)	17
RX OUT (SUB)	17
RX (SUB)	41

S

Safety Precautions	6
Scan Skip Setting	74
Scope Display Setting	24
Screen capture	79
Screen Saver	30
SD memory card slot	33
Selecting the Keyer Operating Mode	60
Setting Menu	83
Setting of the Electronic Keyer	60
Setting the Keyer Weight	60
SHIFT	47
S.MENU	27
SPAN	25
Specifications	115
Speech Processor	51
SPEED	27, 43
SPLIT	37
SPOT	33
SQL (MAIN)	42
SQL (SUB)	43
SSB	36
SSM-75G Microphone Switches	18
SYNC	36

T

Time Out Timer	78
Tone Squelch Operation	65
TOT	78
TUNE	33
TUNER	17
Tuning in 1 MHz or 1 kHz Steps	21
TX Clarifier	39
TX-GND	17
TX (MAIN)	41
TX (SUB)	41

U

USB	17
USB Jack	32
Using the SD Card	80

V

VC TUNE	40
VFO Scanning	76
Voice Communications	50
Voice Memory	54
VOX	33
VOX anti-trip sensitivity	33
VOX Delay Time	33
VOX GAIN	33

W

WIDTH	47
-------------	----

Z

ZIN	33
-----------	----

YAESU LIMITED WARRANTY

Limited Warranty is valid only in the country/region where this product was originally purchased.

On-line Warranty Registration:

Thank you for buying YAESU products! We are confident your new radio will serve your needs for many years! Please register your product at www.yaesu.com - Owner's Corner

Warranty Terms:

Subject to the Limitations of the Warranty and the Warranty Procedures described below, YAESU MUSEN hereby warrants this product to be free of defects in materials and workmanship in normal use during the "Warranty Period." (the "Limited Warranty").

Limitations of Warranty:

- A. YAESU MUSEN is not liable for any express warranties except the Limited Warranty described above.
- B. The Limited Warranty is extended only to the original end-use purchaser or the person receiving this product as a gift, and shall not be extended to any other person or transferee.
- C. Unless a different warranty period is stated with this YAESU product, the Warranty Period is three years from the date of retail purchase by the original end-use purchaser.
- D. The Limited Warranty is valid only in the country/region where this product was originally purchased.
- E. During the Warranty Period, YAESU MUSEN will, at its sole option, repair or replace (using new or re-furnished replacement parts) any defective parts within a reasonable period of time and free of charge.
- F. The Limited Warranty does not cover shipping cost (including transportation and insurance) from you to us, or any import fees, duties or taxes.
- G. The Limited Warranty does not cover any impairment caused by tampering, misuse, failure to follow instructions supplied with the product, unauthorized modifications, or damage to this product for any reasons, such as: accident; excess moisture; lightning; power surges; connection to improper voltage supply; damage caused by inadequate packing or shipping procedures; loss of, damage to or corruption of stored data; product modification to enable operation in another country/purpose other than the country/purpose for which it was designed, manufactured, approved and/or authorized; or the repair of products damaged by these modifications.
- H. The Limited Warranty applies only to the product as it existed at the time of the original purchase, by the original retail purchaser, and shall not preclude YAESU MUSEN from later making any changes in design, adding to, or otherwise improving subsequent versions of this product, or impose upon YAESU MUSEN any obligation to modify or alter this product to conform to such changes, or improvements.
- I. YAESU MUSEN assumes no responsibility for any consequential damages caused by, or arising out of, any such defect in materials or workmanship.
- J. TO THE FULLEST EXTENT PERMITTED BY LAW, YAESU MUSEN SHALL NOT BE RESPONSIBLE FOR ANY IMPLIED WARRANTY WITH RESPECT TO THIS PRODUCT.
- K. If the original retail purchaser timely complies with the Warranty Procedures described below, and YAESU MUSEN elects to send the purchaser a replacement product rather than repair the "original product", then the Limited Warranty shall apply to the replacement product only for the remainder of the original product Warranty Period.
- L. Warranty statutes vary from state to state, or country to country, so some of the above limitations may not apply to your location.

Warranty Procedures:

1. To find the Authorized YAESU Service Center in your country/region, visit www.yaesu.com. Contact the YAESU Service Center for specific return and shipping instructions, or contact an authorized YAESU dealer/distributor from whom the product was originally purchased.
2. Include proof of original purchase from an authorized YAESU dealer/distributor, and ship the product, freight prepaid, to the address provided by the YAESU Service Center in your country/ region.
3. Upon receipt of this product, returned in accordance with the procedures described above, by the YAESU Authorized Service Center, all reasonable efforts will be expended by YAESU MUSEN to cause this product to conform to its original specifications. YAESU MUSEN will return the repaired product (or a replacement product) free of charge to the original purchaser. The decision to repair or replace this product is the sole discretion of YAESU MUSEN.

Other conditions:

YAESU MUSEN'S MAXIMUM LIABILITY SHALL NOT EXCEED THE ACTUAL PURCHASE PRICE PAID FOR THE PRODUCT. IN NO EVENT SHALL YAESU MUSEN BE LIABLE FOR LOSS OF, DAMAGE TO OR CORRUPTION OF STORED DATA, OR FOR SPECIAL, INCIDENTAL, CONSEQUENTIAL, OR INDIRECT DAMAGES, HOW EVER CAUSED; INCLUDING WITHOUT LIMITATION TO THE REPLACEMENT OF EQUIPMENT AND PROPERTY, AND ANY COSTS OF RECOVERING, PROGRAMMING OR REPRODUCING ANY PROGRAM OR DATA STORED IN OR USED WITH THE YAESU PRODUCT.

Some Countries in Europe and some States of the USA do not allow the exclusion or limitation of incidental or consequential damages, or a limitation on how long an implied warranty lasts, so the above limitation or exclusions may not apply. This warranty provides specific rights, there may be other rights available which may vary between countries in Europe or from state to state within the USA.

This Limited Warranty is void if the label bearing the serial number has been removed or defaced.

YAESU

Declaration of Conformity

Type of Equipment: HF/50MHz TRANSCEIVER
Brand Name: YAESU
Model Number: FTDX101MP / FTDX101D
Manufacturer: YAESU MUSEN CO., LTD.
Address of Manufacturer: Tennozu Parkside Building, 2-5-8 Higashi-Shinagawa,
Shinagawa-ku, Tokyo 140-0002 Japan

This device complies with part 15 of the FCC Rules. Operation is subject to the following two conditions; (1) this device may not cause harmful interference, and (2) this device must accept any interference received, including interference that may cause undesired operation.

The technical documentation as required by the Conformity Assessment procedures is kept at the following address:

Company: Yaesu U.S.A.
Address: 6125 Phyllis Drive, Cypress, CA 90630, U.S.A.
Telephone: (714) 827-7600

- Changes or modifications to this device that are not expressly approved by YAESU MUSEN could void the user's authorization to operate this device.
- This device complies with part 15 of the FCC Rules. Operation is subject to the following two conditions: (1) This device may not cause harmful interference, and (2) this device must accept any interference including received, interference that may cause undesired operation.
- The scanning receiver in this equipment is incapable of tuning, or readily being altered, by the User to operate within the frequency bands allocated to the Domestic public Cellular Telecommunications Service in Part 22.
- The YAESU MUSEN is not responsible for any changes or modifications not expressly approved by the party responsible for compliance. Such modifications could void the user's authority to operate the equipment.

This device complies withISED's applicable license-exempt RSS standard(s). Operation is subject to the following two conditions: (1) this device may not cause interference, and (2) this device must accept any interference, including interference that may cause undesired operation of the device.

Le présent appareil est conforme aux CNR d'Industrie Canada applicables aux appareils radio exempts de licence. L'exploitation est autorisée aux deux conditions suivantes : (1) l'appareil ne doit pas produire de brouillage, et (2) l'utilisateur de l'appareil doit accepter tout brouillage radioélectrique subi, même si le brouillage est susceptible d'en compromettre le fonctionnement.

DECLARATION BY MANUFACTURER

The Scanner receiver is not a digital scanner and is incapable of being converted or modified to a digital scanner receiver by any user.

WARNING: MODIFICATION OF THIS DEVICE TO RECEIVE CELLULAR RADIOTELEPHONE SERVICE SIGNALS IS PROHIBITED UNDER FCC RULES AND FEDERAL LAW.

CAN ICES-3 (B) / NMB-3 (B)

This equipment has been tested and found to comply with the limits for a Class B digital device, pursuant to part 15 of the FCC Rules. These limits are designed to provide reasonable protection against harmful interference in a residential installation. This equipment generates, uses, and can radiate radio frequency energy; and, if not installed and used in accordance with the instructions, may cause harmful interference to radio communications. However, there is no guarantee that interference will not occur in a particular installation.

If this equipment does cause harmful interference to radio or television reception, which can be determined by turning the equipment off and on, the user is encouraged to try to correct the interference by one or more of the following measures:

- Reorient or relocate the receiving antenna.
- Increase the separation between the equipment and receiver.
- Connect the equipment into an outlet on a circuit different from that to which the receiver is connected.
- Consult the dealer or an experienced radio/TV technician for help.

EU Declaration of Conformity

We, Yaesu Musen Co. Ltd of Tokyo, Japan, hereby declare that this radio equipment FTDX101MP / FTDX101D is in full compliance with EU Radio Equipment Directive 2014/53/EU. The full text of the Declaration of Conformity for this product is available to view at <http://www.yaesu.com/jp/red>

ATTENTION – Conditions of usage

This transceiver works on frequencies that are regulated and not permitted to be used without authorisation in the EU countries shown in this table. Users of this equipment should check with their local spectrum management authority for licensing conditions applicable for this equipment.

					
AT	BE	BG	CY	CZ	DE
DK	ES	EE	FI	FR	UK
EL	HR	HU	IE	IT	LT
LU	LV	MT	NL	PL	PT
RO	SK	SI	SE	CH	IS
LI	NO	-	-	-	-

Disposal of Electronic and Electrical Equipment

Products with the symbol (crossed-out wheeled bin) cannot be disposed as household waste.

Electronic and Electrical Equipment should be recycled at a facility capable of handling these items and their waste by-products.

Please contact a local equipment supplier representative or service center for information about the waste collection system in your country.



YAESU

The radio

Copyright 2020
YAESU MUSEN CO., LTD.
All rights reserved.

No portion of this manual may be
reproduced without the permission of
YAESU MUSEN CO., LTD.

YAESU MUSEN CO., LTD.

Tennozu Parkside Building
2-5-8 Higashi-Shinagawa, Shinagawa-ku, Tokyo 140-0002 Japan

YAESU USA

6125 Phyllis Drive, Cypress, CA 90630, U.S.A.

YAESU UK

Unit 12, Sun Valley Business Park, Winnall Close
Winchester, Hampshire, SO23 0LB, U.K.

2003A-FS
Printed in Japan



E H 0 6 8 H 2 1 2